



Engineered Wood

CONSTRUCTION GUIDE



WOOD: THE NATURAL CHOICE



Engineered wood products are among the most beautiful and environmentally friendly building materials. They are produced efficiently from a renewable, sustainable, biological resource. Their various sizes and dimensions mean less construction jobsite waste and lower disposal costs. In completed buildings, they store carbon and deliver decades of strong, dependable structural performance. Plus, wood's natural properties, combined with highly efficient wood-frame construction systems, make it a top choice in energy conservation.

Forest land comprises about **33% of the total land** area of the United States^a.



Only about **one-third** of that forest land is open to logging^b.



The volume of annual net timber **growth in the U.S. is 36% higher** than the volume of annual timber removals^c.



American landowners **plant more than 2.5 billion trees** every year^d.



A young, growing forest **produces 1 ton of oxygen** and **absorbs 1.4 tons of CO₂** for every 1 ton of wood^e.



Forests in the United States continue to sequester more carbon than they emit each year, and combined with urban forests and harvested wood products, **offset nearly 15%** of total greenhouse gas emissions in 2012^a.



A FEW FACTS ABOUT WOOD:

Life Cycle Assessment (LCA) measures the long-term green value of wood.

Studies by Consortium for Research on Renewable Industrial Materials (CORRIM) scientifically validate the environmental credentials of wood as a green building product. LCAs examine building products' life cycle—from extraction of the raw material to demolition of the building at the end of its long lifespan. CORRIM found that wood had a more benign environmental footprint than steel or concrete in energy use, climate change, air emissions, water emissions and solid waste production. Report details are available at www.CORRIM.org.

Environmental Product Declarations (EPDs) verify specific products.

The American Wood Council and Canadian Wood Council have published declarations and transparency briefs for engineered wood products, including I-joists, plywood, oriented strand board, glulam, laminated veneer lumber and laminated strand lumber. Use of products with verifiable EPDs may be used toward LEED v4 credit. Similar incentives may be found in Green Globes, the International Green Construction Code and the Architecture 2030 Challenge. EPDs and transparency briefs are available from www.awc.org/greenbuilding/epd.

Wood is the natural choice for the environment, design and strong, resilient construction.

a. U.S. Forest Resource Facts and Historical Trends, U.S. Department of Agriculture, U.S. Forest Service, 2014

b. Consortium for Research on Renewable Industrial Materials (CORRIM)

c. Alvarez, M. The State of America's Forests: Society of American Foresters, 2007

d. Jones, S. Creating a Sustainable Supply for Woody Biomass, Forest Landowners Association, 2011

e. The American Hardwood Information Center, Hardwood Manufacturers Association

RESIDENTIAL & COMMERCIAL CONSTRUCTION WITH ENGINEERED WOOD PRODUCTS

APA engineered wood products are used in a wide range of construction applications. Time-tested panel products are used in traditional wood-frame construction and in combination with other engineered wood products and systems. For low in-place cost, versatility and superior performance, engineered wood systems are simply hard to beat.

This guide from APA is designed as a reference manual for both residential and commercial construction. It contains up-to-date information on APA Performance Rated panels; glulam; I-joists; structural composite lumber; cross-laminated timber; specification practices; floor, wall and roof systems; diaphragms and shear walls; fire-rated systems and methods of finishing.

If what you want to know about engineered wood construction systems is not fully explained here, chances are it is in one of our many other publications. Titles cited throughout this publication are available from the APA website at www.apawood.org. For individual assistance with specific application questions, contact the APA Product Support Help Desk at (253) 620-7400 or www.apawood.org/help.

Notice: The recommendations in this guide apply only to products that bear the APA trademark. Only products bearing the APA trademark are subject to the Association's quality auditing program.

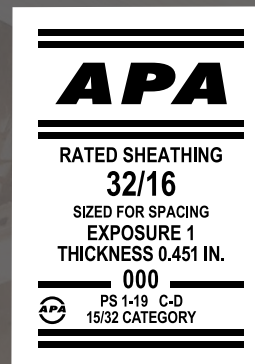

CONTENTS

A GUIDE TO ENGINEERED WOOD PRODUCTS 6

Panel Selection and Specification 7

| | |
|--|----|
| Manufacturing and Performance Standards | 7 |
| Grade Designations | 8 |
| Sanded, Unsanded and Touch-Sanded Panels | 8 |
| Thickness Designation and Performance Category | 8 |
| Sized for Spacing | 11 |
| Bond Classification | 13 |
| Moisture Exposure Recommendations | 14 |
| Group Number | 14 |
| Span Ratings | 15 |
| How to Order APA Panels | 16 |
| Nail Sizes | 17 |
| Metric Conversions | 17 |
| Grade Availability | 17 |
| Panel Storage and Handling | 18 |
| Panel Specification Guide | 19 |

Glulam Selection and

Specification 25

| | |
|---|----|
| Balanced and Unbalanced Beams | 25 |
| Allowable Design Properties | 25 |
| Sizes | 26 |
| Appearance Classification | 26 |
| Section Properties and Capacities | 29 |
| Camber | 29 |
| Trademarks and Acceptance | 30 |
| Glulam Beam Storage and Handling | 30 |
| Glulam Specification Guide | 31 |

Cross-Laminated Timber Selection and Specification 33

| | |
|--|----|
| Applications | 33 |
| Advantages | 33 |
| Allowable Design Capacities | 33 |
| Trademarks and Acceptance | 34 |
| Laminations | 34 |
| Adhesives | 34 |
| Cross-Laminated Timber Specification Guide | 34 |

Structural Composite Lumber

Selection and Specification 35

| | |
|---|----|
| Laminated Veneer Lumber (LVL) | 35 |
| Parallel Strand Lumber (PSL) | 35 |
| Laminated Strand Lumber (LSL) | 35 |

| | |
|---|----|
| Oriented Strand Lumber (OSL) | 35 |
| Allowable Strength Properties | 36 |
| SCL Storage and Handling | 36 |
| Structural Composite Lumber (SCL) Specification Guide | 36 |

I-Joist Selection and Specification 37

| | |
|---|----|
| APA PRI-400 | 37 |
| Residential Floor Spans | 37 |
| I-Joist Storage and Handling | 37 |
| APA Performance Rated I-Joist Specification Guide | 40 |

APA Performance Rated Rim Board®

Selection and Specification 41

| | |
|--|----|
| APA Performance Rated Rim Board® Specification Guide | 42 |
|--|----|

CONSTRUCTION WITH ENGINEERED WOOD PRODUCTS 43

Floor Construction 44

| | |
|--|----|
| APA Rated Sturd-I-Floor® | 45 |
| Sturd-I-Floor 32 oc and 48 oc | 47 |
| The APA Glued Floor System | 47 |
| Application | 49 |
| APA Panel Subflooring | 50 |
| APA Panel Floor Diaphragm | 51 |
| Lightweight Concrete Over APA Panels | 51 |
| APA Plywood Underlayment | 51 |
| Hardwood Flooring Over APA Panel Subfloors | 53 |
| Ceramic Tile Over APA Plywood Floors | 54 |
| APA Panel Stair Treads and Risers | 56 |
| Heavy Duty Plywood Floors | 56 |

Wall Construction 58

| | |
|--|----|
| Continuously Sheathed Wood Walls | 58 |
| APA Panel Wall Sheathing | 58 |
| Wood Structural Panel Wall Bracing and Shear Walls | 60 |
| Wall Bracing | 60 |
| Shear Walls | 62 |
| Designing for Combined Shear and Wind Uplift | 64 |
| Advanced Framing | 65 |
| APA Sheathing Under Stucco | 66 |
| Wood Structural Panel Sheathing as a Nail Base for Siding and Trim | 67 |
| APA Sturd-I-Wall® | 68 |
| Siding Fasteners | 72 |

| | |
|---|----|
| Siding Joint Details | 74 |
| APA Rated Siding Patterns and Grades | 75 |
| Finishing Plywood for Exterior Exposure | 75 |

Roof Construction 78

| | |
|-------------------------------------|----|
| APA Panel Roof Sheathing | 78 |
| Preframed Roof Panels | 80 |
| Long Span Systems | 82 |
| APA Panel Soffits | 83 |
| APA Panel Roof Diaphragms | 84 |

Additional Fire and

Building Systems 87

Fire Systems 87

| | |
|--|----|
| Fire Protection of Residential Floors | 87 |
| Protected Floor/Ceiling Construction | 88 |
| Sprinkler System Installation for I-Joists | 91 |
| Protected Wall Construction | 91 |
| Fire-Rated Roof Coverings | 92 |
| Fire-Rated Structural Glued Laminated Timber Wall and Ceiling Paneling | 92 |

Building Systems 93

| | |
|--|----|
| Heavy Timber Construction | 93 |
| Wind-Resistive Roofs | 94 |
| Noise Transmission Control | 96 |
| Energy Conservation | 97 |
| Air Barrier Materials | 98 |
| Thermal Resistance of Wood Structural Panels | 99 |

Related Panel Systems 100

| | |
|---|-----|
| The Permanent Wood Foundation | 100 |
| Plywood for Concrete Forming | 100 |
| Structural Insulated Panels | 100 |
| APA Panels Over Metal Framing | 101 |
| APA Panel Systems Over Concrete Slabs | 101 |
| Special Floor Surfacing | 101 |

About APA 102

A GUIDE TO ENGINEERED WOOD PRODUCTS

The evolution of engineered wood products has greatly expanded building options and methods in all forms of residential and commercial construction. The product section of this APA guide provides product information and specification recommendations for several of the most common engineered wood products—plywood, oriented strand board, glulam, structural composite lumber (SCL) and I-joists. Other engineered wood products that are often used in the construction systems described in this guide include cross-laminated timber (CLT) and Rim Board®.

“Engineered wood” describes wood products that are engineered for structural applications. Plywood has been used since the 1940s and is considered by many to be the original engineered wood product. Engineered wood products are made by combining wood strands, veneers, lumber or other wood fiber with moisture-resistant adhesives to form a larger composite structural unit. They are designed and manufactured to maximize the natural strength and stiffness characteristics of wood by optimally orienting the wood veneers, strands or laminations and by combining wood with durable structural adhesives.





PANEL SELECTION AND SPECIFICATION

Manufacturing and Performance Standards

Panels for construction and industrial applications can be manufactured in a variety of ways—as structural plywood (cross-laminated wood veneers), oriented strand board (OSB) or other wood-based panel products.

Some structural plywood panels are manufactured under Voluntary Product Standard PS 1 for Structural Plywood, developed cooperatively by the plywood industry, user groups and the U.S. Department of Commerce. Other structural plywood panels, however, as well as OSB panels, are manufactured under Voluntary Product Standard PS 2, Performance Standard for Wood Structural Panels, that establish performance criteria for specific designated construction applications.

These wood structural panels, collectively known as APA Performance Rated Panels, are easy to use and specify because the recommended end use and maximum support spacings are clearly indicated in the APA trademark located on the panel. By broadening the range of panel configurations and compositions, APA Performance Rated Panels allow more efficient use of raw materials. PS 1 and/or the PS 2 grade conformance, where applicable, are given in the lower portion of the APA trademark. Plywood panels manufactured to PS 2 are in many instances identical to panel grades as defined in Product Standard PS 1, depending on bond classification, veneer species, Performance Category and other designations. ANSI/APA PRP 210, *Standard for Performance-Rated Engineered Wood Siding*, covers veneer-based, structural-use products intended for use in construction applications, such as exterior siding. The siding can be in the form of panel or lap with supports spaced in accordance with the span rating of the siding in inches. Typical APA panel trademarks are illustrated and explained on page 8.

TABLE 1

VENEER GRADES

| | |
|---------------------|--|
| A | Smooth, paintable. Not more than 18 neatly made repairs, boat, sled or router type, and parallel to grain, permitted. Wood or synthetic repairs permitted. May be used for natural finish in less demanding applications. |
| B | Solid surface. Shims, sled or router repairs, and tight knots to 1 inch across grain permitted. Wood or synthetic repairs permitted. Some minor splits permitted. |
| C Plugged | Improved C veneer with splits limited to 1/8 inch width and knotholes or other open characteristics limited to 1/4 x 1/2 inch. Wood or synthetic repairs permitted. Admits some broken grain. |
| C | Tight knots to 1-1/2 inches. Knotholes to 1 inch across grain and some to 1-1/2 inches if total width of knots and knotholes is within specified limits. Synthetic or wood repairs. Discoloration and sanding defects that do not impair strength permitted. Limited splits allowed. |
| D | Knots and knotholes to 2-1/2 inch width across grain and 1/2 inch larger within specified limits. Limited splits are permitted. Limited to Exposure 1. |

Grade Designations

Structural panel grades are generally identified in terms of the plywood veneer grades used on the face and back of the panel (e.g., A-B, B-C), or by a name suggesting the panel's intended end use (e.g., APA RATED SHEATHING, APA RATED STURD-I-FLOOR). See Tables 2–4.

Veneer grades define veneer attributes in terms of natural unrepaired growth characteristics and allowable number and size of repairs that may be made during manufacture. See Table 1. The highest quality veneer grade commonly available is A. The minimum grade of veneer permitted in Exterior plywood is C-grade. D-grade veneer is only permitted to be used in panels intended for applications protected from long-term exposure to weather.

Sanded, Unsanded and Touch-Sanded Panels

Plywood panels with B-grade or better veneer faces are always sanded smooth in manufacture to fulfill the requirements of their intended end use—applications such as cabinets, shelving, furniture, built-ins and others. APA RATED SHEATHING including C-C and C-D plywood panels are unsanded since a smooth surface is not a requirement of their intended end use. Still other panels—APA UNDERLAYMENT, APA RATED STURD-I-FLOOR, APA C-D PLUGGED and APA C-C PLUGGED—require only touch-sanding for “sizing” to make the panel thickness more uniform. Unsanded panels, touch-sanded panels and panels with B-grade or better veneer on one side only usually carry the APA trademark on the panel back. Panels with both sides of B-grade or better veneer, or with special overlaid surfaces (such as HIGH DENSITY OVERLAY), usually carry the APA trademark on the panel edge.

Thickness Designation and Performance Category

The thickness tolerance on unsanded panel types used in construction is plus or minus 1/32 inch of the designated thickness up to 11/16 Category and plus or minus 5% for thicker panels. The thickness tolerance on sanded grades of plywood is plus or minus 1/64 inch of the designated thickness up to 11/16 Category and plus or minus 3% for thicker panels. These thickness tolerances are applied at the time of manufacturing or at a standard dry condition since it is recognized that actual panel thickness may naturally change due to changes in panel moisture conditions.

Model codes, technical recommendations, designs and specifications have been based upon the use of these panel nominal thicknesses. However, packaging and labeling regulations adopted as state and local law specify that labeling of dimensions comply with standards developed by the National Conference on Weights and Measures (NIST). To jointly comply with these regulations while maintaining the specifications within model codes and other existing specifications used in the construction industry, structural panels are now labeled with both a Performance Category and a decimal thickness designation. The decimal thickness designation is generally at or near the lower thickness tolerance permitted in PS 1 and PS 2.

a. HUD recognition of wood-based APA Performance Rated Panels is contained in *Use of Materials Bulletin UM-40C*.

TYPICAL APA PANEL TRADEMARKS

The diagram illustrates three typical APA panel trademarks, each with a set of numbered callouts (1-17) pointing to specific parts of the label and panel features. The trademarks are: 1. APA RATED STURD-I-FLOOR 240c, 2. APA RATED SHEATHING 48/24, and 3. APA RATED SIDING 160c GROUP 1. The callouts identify: 1. Panel grade, 2. Span rating, 3. Sizing for spacing, 4. Tongue-and-groove and net width, 5. Siding face grade, 6. Species group number, 7. Bond classification, 8. Decimal thickness designation, 9. Mill number, 10. Product Standard, 11. HUD recognition, 12. Referenced Product Standard, 13. Performance Category, 14. Panel grade, Canadian standard, 15. Panel mark—Rating and end-use designation per the Canadian standard, 16. Canadian performance rated panel standard, and 17. Panel face grain orientation indicator.

TABLE 2

**GUIDE TO APA PERFORMANCE RATED PANELS^{a,b}
FOR APPLICATION RECOMMENDATIONS, SEE FOLLOWING PAGES.**

| | | |
|---|--|---|
| <p>APA RATED SHEATHING Typical Trademark</p> | | <p>Specially designed for subflooring and wall and roof sheathing. Also good for a broad range of other construction and industrial applications. Can be manufactured as OSB, plywood or other wood-based panel. BOND CLASSIFICATIONS: Exterior, Exposure 1. COMMON PERFORMANCE CATEGORIES: 3/8, 7/16, 15/32, 1/2, 19/32, 5/8, 23/32, 3/4.</p> |
| <p>APA STRUCTURAL I RATED SHEATHING^c Typical Trademark</p> | | <p>Unsanded grade for use where shear and cross-panel strength properties are of maximum importance, such as panelized roofs and diaphragms. Can be manufactured as OSB, plywood or other wood-based panel. BOND CLASSIFICATIONS: Exterior, Exposure 1. COMMON PERFORMANCE CATEGORIES: 3/8, 7/16, 15/32, 1/2, 19/32, 5/8, 23/32, 3/4.</p> |
| <p>APA RATED STURD-I-FLOOR Typical Trademark</p> | | <p>Specially designed as combination subfloor-underlayment. Provides smooth surface for application of carpet and pad and possesses high concentrated and impact load resistance. Can be manufactured as OSB, plywood or other wood-based panel. Available square edge or tongue-and-groove. BOND CLASSIFICATIONS: Exterior, Exposure 1. COMMON PERFORMANCE CATEGORIES: 19/32, 5/8, 23/32, 3/4, 7/8, 1-1/8.</p> |
| <p>APA RATED SIDING Typical Trademark</p> | | <p>Panels designed for exterior siding. Can be manufactured as plywood, as other wood-based panel or as an overlaid OSB. Both panel and lap siding available. Special surface treatment such as V-groove, channel groove, deep groove (such as APA Texture 1-11[®]), brushed, rough sawn and overlaid (MDO) with smooth- or texture-embossed face. Span rating indicated in trademark. BOND CLASSIFICATION: Exterior. COMMON PERFORMANCE CATEGORIES: 11/32, 3/8, 7/16, 15/32, 1/2, 19/32, 5/8.</p> |
| <p>APA RATED SHEATHING—WALL Typical Trademark</p> | | <p>Specially designed for wall sheathing. Not intended for roof or floor sheathing. Can be manufactured as OSB, plywood or other wood-based panel. BOND CLASSIFICATION: Exposure 1. COMMON PERFORMANCE CATEGORIES: 3/8, 7/16, 15/32.</p> |

- Specific grades, Performance Categories and bond classifications may be in limited supply in some areas. Check with your supplier before specifying.
- Specify Performance Rated Panels by Performance Category and span rating. Span ratings are based on panel strength and stiffness. Since these properties are a function of panel composition and configuration as well as thickness, the same span rating may appear on panels of different Performance Categories. Conversely, panels of the same Performance Category may be marked with different span ratings.
- For Structural I plywood panel constructions, the plies are special improved grades. Panels marked PS 1 are limited to Group 1 species. Other panels marked Structural I qualify through special performance testing.

TABLE 3

**GUIDE TO APA SANDED AND TOUCH-SANDED PLYWOOD PANELS^{a,b}
FOR APPLICATION RECOMMENDATIONS, SEE FOLLOWING PAGES.**

| | | |
|--|---|---|
| <p>APA A-A Typical Trademark (mark on panel edge) APA A-A G-1 EXT 0.734 IN. 000 PS 1-19 3/4 CAT </p> | | <p>Use where appearance of both sides is important for interior applications such as built-ins, cabinets, furniture, partitions; and exterior applications such as fences, signs, boats, shipping containers, tanks, ducts, etc. Smooth surfaces suitable for painting. BOND CLASSIFICATIONS: Exterior. COMMON PERFORMANCE CATEGORIES: 1/4, 11/32, 3/8, 15/32, 1/2, 19/32, 5/8, 23/32, 3/4.</p> |
| <p>APA A-B Typical Trademark (mark on panel edge) APA A-B G-1 EXT 0.234 IN. 000 PS 1-19 1/4 CAT </p> | | <p>For use where appearance of one side is less important but where two solid surfaces are necessary. BOND CLASSIFICATIONS: Exterior. COMMON PERFORMANCE CATEGORIES: 1/4, 11/32, 3/8, 15/32, 1/2, 19/32, 5/8, 23/32, 3/4.</p> |
| <p>APA A-C Typical Trademark</p> |  <p>The logo for APA A-C Group 1 features the word 'APA' in a bold, serif font between two horizontal lines. Below this, it reads 'A-C GROUP 1', 'EXTERIOR THICKNESS 0.703 IN.', '000', 'PS 1-19', and '23/32 CATEGORY'.</p> | <p>For use where appearance of only one side is important in exterior or interior applications, such as soffits, fences, farm buildings, etc.^c BOND CLASSIFICATION: Exterior. COMMON PERFORMANCE CATEGORIES: 1/4, 11/32, 3/8, 15/32, 1/2, 19/32, 5/8, 23/32, 3/4.</p> |
| <p>APA B-B Typical Trademark (mark on panel edge) APA B-B G-2 EXT 0.578 IN. 000 PS 1-19 19/32 CAT </p> | | <p>Panels with two solid sides. BOND CLASSIFICATIONS: Exterior. COMMON PERFORMANCE CATEGORIES: 1/4, 11/32, 3/8, 15/32, 1/2, 19/32, 5/8, 23/32, 3/4.</p> |
| <p>APA B-C Typical Trademark</p> |  <p>The logo for APA B-C Group 1 features the word 'APA' in a bold, serif font between two horizontal lines. Below this, it reads 'B-C GROUP 1', 'EXTERIOR THICKNESS 0.703 IN.', '000', 'PS 1-19', and '23/32 CATEGORY'.</p> | <p>Panel for farm service and work buildings, boxcar and truck linings, containers, tanks, agricultural equipment, as a base for exterior coatings and other exterior uses or applications subject to high or continuous moisture.^c BOND CLASSIFICATION: Exterior. COMMON PERFORMANCE CATEGORIES: 1/4, 11/32, 3/8, 15/32, 1/2, 19/32, 5/8, 23/32, 3/4.</p> |

- a. Specific plywood grades, Performance Categories and bond classifications may be in limited supply in some areas. Check with your supplier before specifying.
- b. Touch-sanded Exterior plywood panels, C-C Plugged, C-D Plugged and Underlayment grades can also be manufactured in Structural I (all plies limited to Group 1 species).
- c. For nonstructural floor underlayment, or other applications requiring improved inner ply construction, specify panels marked either "plugged inner plies" (may also be designated "plugged crossbands under face" or "plugged crossbands" or "core"); or "meets underlayment requirements."

Continued on next page

TABLE 3 (Continued)

**GUIDE TO APA SANDED AND TOUCH-SANDED PLYWOOD PANELS
FOR APPLICATION RECOMMENDATIONS, SEE FOLLOWING PAGES.**

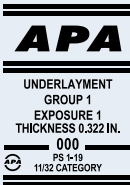
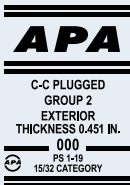
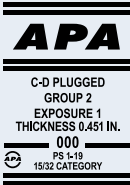
| | | |
|--|---|---|
| <p>APA UNDERLAYMENT Typical Trademark</p> |  <p>APA UNDERLAYMENT GROUP 1 EXPOSURE 1 THICKNESS 0.322 IN. 000 PS 1-19 11/32 CATEGORY</p> | <p>For application over structural subfloor. Provides smooth surface for application of carpet and pad and possesses high concentrated and impact load resistance. For areas to be covered with resilient flooring, specify panels with “sanded face.”^d BOND CLASSIFICATION: Exposure 1 or Exterior. COMMON PERFORMANCE CATEGORIES^e: 1/4, 11/32, 3/8, 15/32, 1/2, 19/32, 5/8, 23/32, 3/4.</p> |
| <p>APA C-C PLUGGED^f Typical Trademark</p> |  <p>APA C-C PLUGGED GROUP 2 EXTERIOR THICKNESS 0.451 IN. 000 PS 1-19 15/32 CATEGORY</p> | <p>For use as an underlayment over structural subfloor, refrigerated or controlled atmosphere storage rooms, pallet fruit bins, tanks, boxcar and truck floors and linings, open soffits and other similar applications where continuous or severe moisture may be present. Provides smooth surface for application of carpet and pad and possesses high concentrated and impact load resistance. For areas to be covered with resilient flooring, specify panels with “sanded face.”^d BOND CLASSIFICATION: Exterior. COMMON PERFORMANCE CATEGORIES^e: 11/32, 3/8, 15/32, 1/2, 19/32, 5/8, 23/32, 3/4.</p> |
| <p>APA C-D PLUGGED Typical Trademark</p> |  <p>APA C-D PLUGGED GROUP 2 EXPOSURE 1 THICKNESS 0.451 IN. 000 PS 1-19 15/32 CATEGORY</p> | <p>For open soffits, built-ins, cable reels, separator boards and other interior or protected applications. Not a substitute for Underlayment or APA Rated Sturd-I-Floor as it lacks their puncture resistance. BOND CLASSIFICATION: Exposure 1. COMMON PERFORMANCE CATEGORIES: 3/8, 15/32, 1/2, 19/32, 5/8, 23/32, 3/4.</p> |

d. Also available in Underlayment A-C or Underlayment B-C grades, marked either “touch-sanded” or “sanded face.”
e. Some panels with Performance Categories of 1/2 and larger are span rated and do not contain species group number in trademark.
f. Also may be designated APA Underlayment C-C Plugged.

The term “Performance Category” is defined within PS 1 and PS 2 as a panel designation related to the panel thickness range that is linked to the nominal panel thickness designations used in the International Building Code (IBC) and International Residential Code (IRC). For purposes of labeling, abbreviations PERF CAT, CAT or Category are permitted within the panel grade mark. The 2018 and 2015 International Building Code (IBC) and International Residential Code (IRC) state that the Performance Category value shall be used as the “nominal panel thickness” or “panel thickness” whenever referenced in the code.





This publication widely uses the Performance Category as the panel designation. There are some places where traditional nominal thickness designations are used, and in those instances, they should be considered as equivalent to the Performance Category.

Sized for Spacing

“Sized for Spacing” is an optional notation with the panel trademark indicating that the panel has been produced at a length and width slightly less than traditional nominal length and width. This is done to facilitate proper panel spacing during construction in order to accommodate natural panel expansion that occurs as the panel acclimates to construction or in-service moisture conditions.

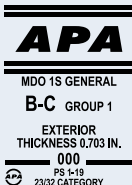
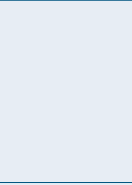
TABLE 4

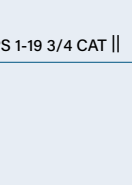
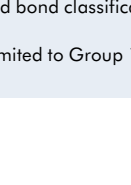
GUIDE TO APA SPECIALTY PLYWOOD PANELS^a
FOR APPLICATION RECOMMENDATIONS, SEE FOLLOWING PAGES.

| | | |
|---|---|--|
| <p>APA Decorative Typical Trademark</p> |  | <p>Typically, rough-sawn, often with grooves. For paneling, interior accent walls, built-ins, counter facing, exhibit displays. Can also be made by some manufacturers in Exterior for exterior siding, gable ends, fences and other exterior applications. Use recommendations for Exterior panels vary with the particular product. Check with the manufacturer. BOND CLASSIFICATIONS: Exposure 1, Exterior. COMMON PERFORMANCE CATEGORIES: 5/16, 3/8, 1/2, 5/8.</p> |
| <p>APA High Density Overlay (HDO)^b Typical Trademark (mark on panel edge) APA HDO INDUSTRIAL A-A G-2 EXT 0.734 IN. 000 PS 1-19 3/4 CAT </p> |  | <p>Has a hard opaque resin-fiber overlay on one or both faces. Abrasion-resistant. For concrete forms, cabinets, countertops, signs, tanks. Also available with skid-resistant screen-grid surface. HDO is manufactured in two grades: Concrete Form and Industrial. BOND CLASSIFICATION: Exterior. COMMON PERFORMANCE CATEGORIES: 11/32, 3/8, 15/32, 1/2, 19/32, 5/8, 11/16, 23/32, 3/4.</p> |
| <p>APA Medium Density Overlay (MDO)^b Typical Trademark</p> |  | <p>Smooth, opaque, resin-fiber overlay on one or both faces. Ideal base for paint, both indoors and outdoors. For exterior siding, paneling, shelving, exhibit displays, cabinets, concrete forms, signs. MDO is manufactured in two grades: Concrete Form and General. BOND CLASSIFICATION: Exterior. COMMON PERFORMANCE CATEGORIES: 11/32, 3/8, 15/32, 1/2, 19/32, 5/8, 11/16, 23/32, 3/4.</p> |
| <p>APA Marine Typical Trademark (mark on panel edge) APA MARINE A-A EXT 0.609 IN. 000 PS 1-19 5/8 CAT </p> |  | <p>Ideal where solid cores are needed, such as boat hulls, or where application demands smooth face and minimal voids. Made only with Douglas-fir or western larch. Subject to special limitations on core gaps and face repairs. Also available with HDO or MDO faces. BOND CLASSIFICATION: Exterior. COMMON PERFORMANCE CATEGORIES: 1/4, 3/8, 1/2, 5/8, 3/4.</p> |
| <p>APA Plyform Class I^b Typical Trademark</p> |  | <p>Concrete form grades. Sanded both faces and mill-oiled unless otherwise specified. Special restrictions on species. Also available in HDO or MDO for very smooth concrete finish, and with special overlays for higher re-use factors. BOND CLASSIFICATION: Exterior. COMMON PERFORMANCE CATEGORIES: 19/32, 5/8, 11/16, 23/32, 3/4.</p> |
| <p>Typical Trademark (mark on panel edge) APA HDO CONCRETE FORM STRUC I EXT 0.734 IN. 000 PS 1-19 3/4 CAT </p> |  | <p>Hardboard face on both sides. Faces tempered, untempered, smooth or screened. For countertops, shelving, cabinet doors, flooring. BOND CLASSIFICATIONS: Exposure 1, Exterior. COMMON PERFORMANCE CATEGORIES: 1/2, 5/8, 3/4.</p> |
| <p>APA Plyron Typical Trademark (mark on panel edge) APA TEMPERED PLYRON EXT 0.734 IN. 000 3/4 CAT APA STANDARD PLYRON EXP 1 0.734 IN. 000 3/4 CAT </p> |  | <p>Hardboard face on both sides. Faces tempered, untempered, smooth or screened. For countertops, shelving, cabinet doors, flooring. BOND CLASSIFICATIONS: Exposure 1, Exterior. COMMON PERFORMANCE CATEGORIES: 1/2, 5/8, 3/4.</p> |

a. Specific plywood grades, Performance Category and bond classifications may be in limited supply in some areas. Check with your supplier before specifying.

b. Can also be manufactured in Structural I (all plies limited to Group 1 species).

Bond Classification

All engineered wood products that bear the APA trademark are manufactured to standards that require the use of moisture-resistant adhesives. The moisture-resistant adhesives are known to provide bond strength stability over time, despite fluctuating moisture conditions. This stability also provides very low, or nonexistent, formaldehyde emission rates. As a result, the APA trademarked engineered wood products described here have been exempted from formaldehyde emission regulations imposed upon nonstructural wood composite products such as the Airborne Toxic Control Measures (ATCM) from the California Air Resources Board (CARB) and the U.S. EPA's Toxic Substances Control Act Title VI (TSCA VI). For additional information on the formaldehyde emissions from engineered wood products, see *APA Technical Note: Formaldehyde and Engineered Wood Products*, Form J330.

APA trademarked panels may be produced in two moisture-resistant bond classifications—Exterior and Exposure 1. The bond classification is defined by the applicable standard and relates to moisture resistance of the glue bond. Since aesthetic (nonstructural) attributes of panels may be compromised to some degree by exposure to weather, installation recommendations in this publication are designed to provide optimum overall performance.

Bond classification of the panel does not relate to fungal decay resistance of the panel. Fungal decay of wood products may occur when the moisture content exceeds 20% for an extended period. See *APA Technical Note, Controlling Decay in Wood Construction*, Form R495, for a discussion of fungal decay. Prevention of fungal decay is a function of proper design, material specification, construction and maintenance of the structure. While this publication includes many of the applicable provisions, reference to local building codes and other design documents is also necessary.

Exterior panels have bonds capable of withstanding repeated wetting and redrying or long-term exposure to weather or other conditions of similar severity.

Exposure 1 panels are suitable for uses not involving long-term exposure to weather. Panels classified as Exposure 1 are intended to resist the effects of moisture on structural performance during construction or other conditions of similar severity. Exposure 1 panels may also be used when exposure to the outdoors is protected from direct exposure, such as the under side of panels at roof overhangs, although appearance characteristics of the panel grade should also be considered. Exposure 1 panels are made with the same exterior adhesives used in Exterior panels. However, because other panel compositional factors may affect bond performance, only Exterior panels should be used for long-term exposure to the weather.

C-D Exposure 1 APA Rated Plywood Sheathing, sometimes called “CDX” in the trade, is occasionally mistaken as an Exterior panel and erroneously used in applications for which it does not possess the required resistance to weather. “CDX” should only be used for applications as outlined under Exposure 1 above. For sheathing grade panels that will be exposed long-term to the weather, specify APA Rated Sheathing Exterior (C-C Exterior plywood under PS 1).

Moisture Exposure Recommendations

APA recommendations take into account bond classification as well as other panel compositional factors that may affect bond or panel performance.

Table 5 provides guidance regarding moisture content and recommended bond classification.

By far, most wood structural panels are used in interior or dry-use moisture conditions, where in-service moisture content will be less than 16% over the service life. In North America, the typical in-service equilibrium moisture content is in the 8% to 12% range for wood structural panels. Occasionally, however, an application will subject panels to higher long-term moisture conditions, such as in locations where relative humidity is 90% or more for long periods of time.

Group Number

Structural plywood can be manufactured from over 70 species of wood. These species are divided on the basis of strength and stiffness into five Groups under PS 1. Strongest species are in Group 1, the next strongest in Group 2 and so on. The Group number that appears in the trademark on some APA trademarked panels, primarily panels with no span rating, is based on the species used for face and back veneers or upon equivalent strength testing of the panel. Where face and back veneers are not from the same species Group, the higher Group number is used, except for sanded panels 3/8 Category and less and decorative panels of any thickness. These are identified by face species because they are chosen primarily for appearance and used in applications where structural integrity is not critical. Sanded panels greater than 3/8 Category are identified by face species if C or D grade backs are at least 1/8 inch and are no more than one species group number larger. Some species are used widely in plywood manufacture; others rarely. Check local availability if a particular species is desired.

TABLE 5

RECOMMENDED BOND CLASSIFICATIONS FOR END-USE MOISTURE CONDITIONS

| In-Service Moisture Content | End-Use Moisture Conditions | Recommended Bond Classification | Design Moisture Conditions ^a |
|-----------------------------|----------------------------------|---------------------------------|---|
| Less than 16% | Dry uses | Exposure 1 or Exterior | Dry |
| 16% to 19% | Humid interior or protected uses | Exposure 1 or Exterior | Wet |
| Greater than 19% | Long-term exposure to weather | Exterior | Wet |
| | Other very humid or wet uses | Exterior ^b | Wet |
| | Ground contact | Exterior ^b | Wet |

a. Contact APA for specific design provisions.

b. Recommend pressure treatment.

Span Ratings

APA RATED SHEATHING, APA RATED STURD-I-FLOOR and APA RATED SIDING carry numbers in their trademarks called span ratings. These denote the maximum recommended center-to-center spacing in inches of supports over which the panels should be placed in normal code-conforming construction. Except for APA RATED SIDING panels, the span rating applies when the long panel dimension or strength axis is across supports, unless the strength axis is otherwise identified on the panel. The span rating of APA RATED SIDING panels applies when panels are installed vertically (parallel to studs).

The span rating on APA RATED SHEATHING panels appears as two numbers separated by a slash, such as 32/16, 48/24, etc.^a The left-hand number denotes the maximum recommended spacing of supports when the panel is used for roof sheathing with the strength axis of the panel across three or more supports (two or more spans). The right-hand number denotes the maximum recommended spacing of supports when the panel is used for subflooring with the strength axis of the panel across three or more supports (two or more spans). A panel marked 32/16, for example, may be used for roof decking over supports up to 32 inches on center or for subflooring over supports up to 16 inches on center. When APA RATED SHEATHING is used for roof decking and subfloor applications, see Tables 33 and 15, respectively, for recommended live-load capacities.

The span rating on APA RATED STURD-I-FLOOR and APA RATED SIDING panels appears as a single number. APA RATED STURD-I-FLOOR panels are designed specifically for single-floor (combined subfloor-underlayment) applications under carpet and pad and are manufactured with span ratings of 16, 20^b, 24, 32 and 48. The span ratings for APA RATED STURD-I-FLOOR panels, like those for APA RATED SHEATHING, are based on application of the panel with the strength axis of the panel across three or more supports (two or more spans). When APA RATED STURD-I-FLOOR is used for single-floor applications, see Table 15 for recommended live load capacities. APA RATED STURD-I-FLOOR may be also used in roof decking applications. For such applications, see Table 33 for recommended roof live load capacities.

APA RATED SIDING is available with span ratings of 16 and 24 inches. Span-rated panels and lap siding may be used direct to studs or over nonstructural wall sheathing, or over nailable panel (see Table 26) or lumber sheathing (double wall construction). Panels and lap siding with a span rating of 16 inches may be applied direct to studs spaced 16 inches on center. Panels and lap siding bearing a span rating of 24 inches may be used direct to studs 24 inches on center. All RATED SIDING panels may be applied horizontally direct to studs 16 or 24 inches on center, provided horizontal joints are blocked. When used over structural sheathing, the span rating of APA RATED SIDING panels refers to the maximum recommended spacing of vertical rows of fasteners rather than to stud spacing.

For a description of span ratings under the Canadian Standard for Construction Sheathing, refer to the *APA Product Guide: Oriented Strand Board*, Form W410.

a. An exception is APA RATED SHEATHING intended for use as wall sheathing only. The trademarks for such panels contain a single number similar to the span rating for APA RATED SIDING.

b. For span rating of 20, actual support spacing is 19.2 inches.

How to Order APA Panels

Sanded and Touch-Sanded Panels: Designate Performance Category, APA trademark, grade, Group number^a, bond classification, dimensions, number of pieces. For example:

- 3/4 Category APA A-A, Group 1, Exterior, nom. 4x8, 100 pcs.
- 3/8 Category APA Underlayment, Group 1, Exposure 1, nom. 4x8, 100 pcs.

Designate “sanded face” if panels are to be used under resilient flooring, or see Table 17 for additional information.

Performance Rated Panels: Designate Performance Category, APA trademark, grade, span rating, bond classification, dimensions, number of pieces. For example:

- 15/32 Category APA RATED SHEATHING, 32/16, Exposure 1, nom. 4x8, 100 pcs.
- 23/32 Category APA RATED STURD-I-FLOOR 24 oc, Exposure 1, nom. 4x8, 100 pcs. Note “square edge” or “tongue-and-groove” as desired.

Rated Siding: Designate Performance Category, APA trademark, face grade (for APA RATED SIDING 303), span rating, texture, pattern, dimensions, number of pieces. For example:

- 19/32 Category APA RATED SIDING 303-18-W, 16 oc, rough-sawn Texture 1-11, grooves 4" o.c., nom. 4x8, 100 pcs. Note manufacturer's trade name if desired.

Concrete Form: Designate Performance Category, APA trademark, Class, dimensions, number of pieces. For example:

- 3/4 Category APA PLYFORM Class I, nom. 4x8, 100 pcs.

Plyform panels are manufactured only as Exterior panels and are available mill-oiled and edge-sealed (OES) if specified.

Overlaid Panels: Designate Performance Category, APA trademark, grade, Group number, dimensions, number of pieces. For example:

- 1/2 Category APA MEDIUM DENSITY OVERLAY (MDO) CONCRETE FORM or (APA RATED SIDING 303-OL in the case of overlaid panels produced under the APA RATED SIDING 303 manufacturing specification), Group 1, nom. 4x8, 100 pcs.

Any special requirements, such as only one side overlaid, surface texture or weight of surfacing material, should be stated after the standard specification.

a. Underlayment and C-C Plugged panels Performance Category 1/2 and larger are generally span rated and may not contain species group number in trademark. Designate span rating.

Nail Sizes

Various nail penny sizes are referenced throughout this document. For most cases, the appropriate lengths and wire diameters can be found in Table 6.

Metric Conversions

Metric equivalents of panel thickness and common sizes of wood structural panels are tabulated in Tables 7 and 8 (1 inch = 25.4 millimeters).

Grade Availability

Some panel grades, Performance Categories, span ratings or species may be difficult to obtain in some areas. Check with local supplier for availability or include an alternate panel in specifications. Standard panel dimensions are 4 feet by 8 feet, although some mills also produce larger or smaller panels.

TABLE 6

NAIL SIZES (ASTM F1667)

| Penny Size | Type | Length (in.) | Wire Diameter (in.) |
|------------|-----------------------------------|--------------|---------------------|
| 3d | Ring- or screw-shank | 1-1/4 | 0.099 ^a |
| | Finish | 1-1/2 | 0.072 |
| 4d | Box and Casing | 1-1/2 | 0.080 |
| | Ring- or Screw-shank | 1-1/2 | 0.099 ^a |
| 6d | Finish | 2 | 0.092 |
| | Box and Casing | 2 | 0.099 |
| | Siding | 1-7/8 | 0.106 |
| | Common | 2 | 0.113 |
| 8d | Ring- or Screw-shank | 2 | 0.120 ^a |
| | Finish | 2-1/2 | 0.099 |
| | Box and Casing | 2-1/2 | 0.113 |
| 10d | Siding | 2-3/8 | 0.128 |
| | Common | 2-1/2 | 0.131 |
| | Ring- or Screw-shank ^a | 2-1/2 | 0.120 or 0.131 |
| 16d | Box and Casing | 3 | 0.128 |
| | Common | 3 | 0.148 |
| 16d | Box and Casing | 3-1/2 | 0.135 |
| | Common | 3-1/2 | 0.162 |
| | Sinker | 3-1/4 | 0.148 |

a. The use of penny weight for ring- or screw-shank nails is not recommended. International Staple, Nail and Tool Association (ISANTA) recommends to specify nail length x nail diameter and nail type (ring-shank nail, screw-shank nail, or deformed-shank nail), such as 1-1/4" x 0.099" ring-shank nail.

TABLE 7

PANEL DIMENSIONS (Width x Length)

| feet | Metric Soft Conversion, mm | Canadian Customary, mm |
|--------|----------------------------|------------------------|
| 4 x 8 | 1220 x 2440 | 1200 x 2400 |
| 4 x 9 | 1220 x 2740 | 1200 x 2700 |
| 4 x 10 | 1220 x 3050 | 1200 x 3000 |

TABLE 8

PANEL THICKNESS

| inches | Metric Soft Conversion, mm | Canadian Customary, mm |
|--------|----------------------------|------------------------|
| 1/4 | 6.4 | – |
| 5/16 | 7.9 | 7.5 |
| 11/32 | 8.7 | – |
| 3/8 | 9.5 | 9.5 |
| 7/16 | 11.1 | 11 |
| 15/32 | 11.9 | 12 |
| 1/2 | 12.7 | 12.5 |
| 9/16 | 14.3 | – |
| 19/32 | 15.1 | 15 |
| 5/8 | 15.9 | 15.5 |
| 11/16 | 17.5 | – |
| 23/32 | 18.3 | 18 |
| 3/4 | 19.1 | 18.5 |
| 7/8 | 22.2 | 22 |
| 1 | 25.4 | 25 |
| 1-3/32 | 27.8 | – |
| 1-1/8 | 28.6 | 28.5 |

Panel Storage and Handling

Like all building materials, APA trademarked wood structural panels should be properly stored, handled and installed to assure superior in-service performance.

Protect the edges and ends of panels, especially tongue-and-groove and shiplap-edged panels. Place panels to be moved by forklift on pallets or bunks when received to avoid damage by fork tines.

Panels to be transported on open truck beds should be covered with standard tarpaulins or lumber wraps. For open railcar shipment, use lumber wrap to avoid extended weather exposure.

Whenever possible, store panels under a roof, especially if they won't be used soon after received. Keep sanded and other appearance grades away from open doorways and weight down the top panel in a stack to help avoid any possible warpage from humidity. If moisture absorption is expected, cut steel banding on panel bundles to prevent edge damage.

Panels to be stored outside should be stacked on a level platform supported by 4x4 stringers or other blocking. Never leave panels or the platform in direct contact with the ground. Use at least three full-width supports along the 8-foot length of the panel—one centered and the others 12 to 16 inches from each end.

Cover the stack loosely with plastic sheets or tarps. Anchor the covering at the top of the stack, but keep it open and away from the sides and bottom to assure good ventilation. Tight coverings prevent air circulation and, when exposed to sunlight, create a “greenhouse” effect which may encourage mold formation.

PANEL STORAGE

- ① Build platform of cull panel and scrap lumber 4x4s for stacking panels

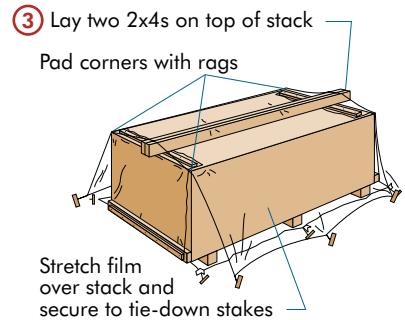
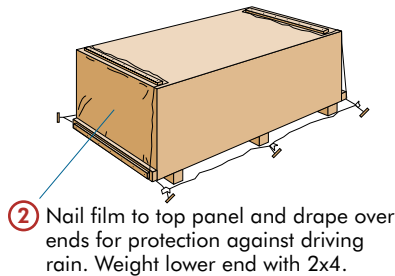
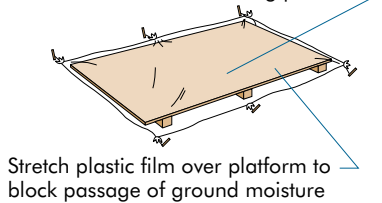

For more information on special characteristics and properties of APA trademarked wood structural panels, visit PerformancePanels.com.

Panel Specification Guide¹

CSI* DIVISION 3—CONCRETE FORMWORK

A. Materials

1. **Forms**—Plywood concrete forms shall be (specify appropriate grade):²

APA PLYFORM CLASS I EXT,

APA HIGH DENSITY OVERLAY CONCRETE FORM PLYFORM CLASS I EXT, or

APA MEDIUM DENSITY OVERLAY CONCRETE FORM PLYFORM CLASS I EXT.

Use plywood thickness sufficient to support concrete at temperature and rate poured³; securely brace and shore forms to prevent displacement and to safely support construction loads.

CSI* DIVISION 6—WOOD AND PLASTICS

A. General Provisions

1. **Identification Requirements**—Each panel shall be identified with the appropriate trademark of APA, and shall meet the requirements of the latest edition of Voluntary Product Standard PS 1, Voluntary Product Standard PS 2 or ANSI/APA PRP-210.
2. All panels which have any edge or surface exposed long term to the weather shall be classed Exterior.^{4,5}
3. Panel Performance Category, grade and Group number or span rating shall be at least equal to that shown on the drawings.⁶ Application shall be in accordance with recommendations of APA.⁷

B. Roof Sheathing

1. Panel roof sheathing shall be (specify appropriate grade):

APA RATED SHEATHING EXP 1

APA RATED SHEATHING EXT

APA RATED SHEATHING/CEILING DECK EXP 1

APA STRUCTURAL I RATED SHEATHING EXP 1, or

APA STRUCTURAL I RATED SHEATHING EXT.

Sheathing exposed long term to weather shall be classed Exterior.⁵

Install with the long dimension or strength axis of the panel across supports, except where noted⁸, and with panel continuous over two or more spans. For pitched roofs, place screened surface or side with skid-resistant coating up, if OSB panels are used. Wear skid-resistant shoes when installing roof sheathing and keep roof deck free of dirt, debris and sawdust during construction. Suitable edge support shall be provided where indicated on drawings (or in recommendations of APA)⁶ by use of panel clips, tongue-and-groove edges or lumber blocking between joists. Panel end joints shall occur over framing.

Spacing of 1/8" is recommended at all panel ends and edges, unless otherwise indicated by the panel manufacturer.⁹

Unless special nail provisions are required (e.g., high wind areas), nail 6" o.c. along supported panel edges and 12" o.c. at intermediate supports, except when supports are spaced 48" o.c. or more, space nails 6" o.c. at all supports. Use 8d common nails, except when panels have a Performance Category of 1-1/8, use 8d ring-shank or 10d common.^{10,11,12,13}

Cover roof sheathing as soon as possible with roofing felt or shingle underlayment for protection against excessive moisture prior to roofing application.

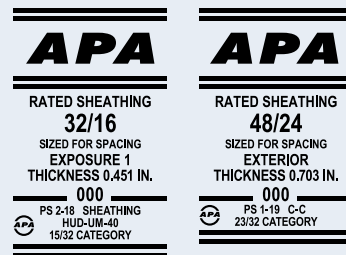

*Construction Specifications Institute

Notes to Panel Specification Guide on page 24.

C. Floors

1. **Subflooring (under structural finish floor such as wood strip or underlayment)**—Panel subflooring shall be (specify appropriate grade):

- APA RATED SHEATHING EXP 1
- APA RATED SHEATHING EXT
- APA STRUCTURAL I RATED SHEATHING EXP 1, or
- APA STRUCTURAL I RATED SHEATHING EXT.

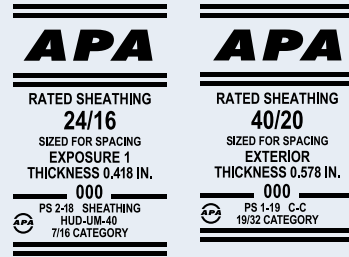

Install with the long dimension or strength axis of the panel across supports and with panel continuous over two or more spans. Panel end joints shall occur over framing. Spacing of 1/8" is recommended at panel ends and edges,⁹ unless otherwise indicated by the panel manufacturer.

Nail 6" o.c. along supported panel edges and 12" o.c. at intermediate supports with 6d common nails for panels with a Performance Category of 1/2 or smaller, 8d for greater Performance Categories.¹³ Where panels have a Performance Category of 1-1/8 and supports are 48" o.c., nails shall be 8d ring-shank or 10d common and spaced 6" o.c. at all supports.^{10,11,12,13}

Sand subfloor joints if necessary to smooth surface prior to installing underlayment or finish flooring.

2. **Combined subfloor-underlayment (under carpet and pad)**¹⁴—

Combined subfloor-underlayment panels shall be (specify appropriate grade):

- APA RATED STURD-I-FLOOR EXP 1, or
- APA RATED STURD-I-FLOOR EXT.

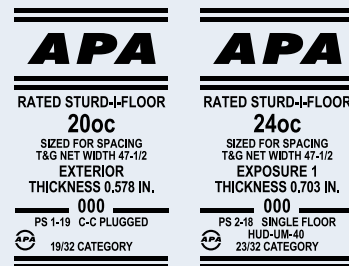

Install with the long dimension or strength axis of the panel across supports and with panel continuous over two or more spans. Panel edges shall be tongue-and-groove or supported on 2-inch lumber blocking installed between joists. Protect against damage until finish floor is installed.

Stagger panel end joints. Panel end joints shall occur over framing. Spacing of 1/8" is recommended at panel ends and edges, unless otherwise indicated by the panel manufacturer.⁹

For nailed floors, nail panels 6" o.c. at supported panel edges and 12" o.c. at intermediate supports, except that when supports are spaced 48" o.c., space nails 6" o.c. at all supports. Use 6d ring- or screw-shank nails for panels with a Performance Category of 3/4 and smaller, and 8d for thicker panels.¹³ With Performance Category 1-1/8 panels, 10d common nails may be used if supports are well seasoned.^{10,11,12,13}

Fill and thoroughly sand edge joints.¹⁵ Lightly sand any surface roughness, particularly around fasteners.

For field-glued floors, use adhesives meeting ASTM D3498 or APA Specification AFG-01, applied in accordance with the manufacturer's recommendations. If OSB panels with sealed surfaces and edges are used, use only solvent-based glues; check with panel manufacturer. Apply continuous line of glue (1/4" thick) on joists and continuous or spaced line of glue (1/8" thick) in groove of tongue-and-groove panels. Use 6d ring- or screw-shank nails spaced 6" o.c. at panel ends and 12" o.c. at intermediate bearings.^{10,13,16}

3. **Underlayment (over subflooring)**—

Plywood underlayment shall be (specify appropriate grade):¹⁷

- APA UNDERLAYMENT EXP 1
- APA UNDERLAYMENT C-C PLUGGED EXT, or
- APA C-C PLUGGED EXT.

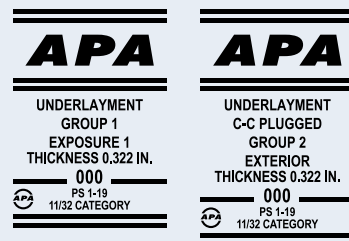

Notes to Panel Specification Guide on page 24.

Plywood Performance Category 19/32 or greater, APA RATED STURD-I-FLOOR EXP 1 or APA RATED STURD-I-FLOOR EXT may be specified. Apply underlayment just prior to laying finish floor and protect against damage until finish floor is installed.

For maximum stiffness, install underlayment with the face grain across supports. Stagger underlayment end joints at least one joist spacing (optional under carpet and pad) with respect to subfloor end joints and offset all edge joints by at least 2 inches from edge joints in the subfloor panels. Underlayment panel end joints should be offset two inches from framing below subfloor to avoid nailing into framing (which may lead to nail pops). Butt panel ends and edges to a close but not tight fit (1/32" space is recommended). Nail 6" o.c. along panel edges and 8" o.c. each way throughout remainder of panel with 3d ring-shank nails for panel Performance Categories of 11/32 to 1/2, or 4d spaced 6" o.c. along edges and 12" o.c. each way for panel Performance Categories up to 3/4.^{11,13,18} Fastener length should be slightly longer than the total thickness of the underlayment and subfloor.

Fill and thoroughly sand edge joints.¹⁵ Lightly sand any surface roughness, particularly around fasteners.

D. Wall Sheathing

1. Panel wall sheathing shall be (specify appropriate grade):

APA RATED SHEATHING EXP 1
 APA RATED SHEATHING EXT
 APA STRUCTURAL I RATED SHEATHING EXP 1,
 APA STRUCTURAL I RATED SHEATHING EXT, or

Spacing of 1/8" is recommended at panel ends and edges, unless otherwise indicated by the panel manufacturer.⁹

Unless special nail provisions are required (e.g., high wind areas), nail 6" o.c. along supported panel edges and 12" o.c. at intermediate supports with 6d common nails for panels with a Performance Category of 1/2 and smaller, and 8d for greater Performance Category.^{10,12,13}

Apply weather-resistant barrier over panel wall sheathing.

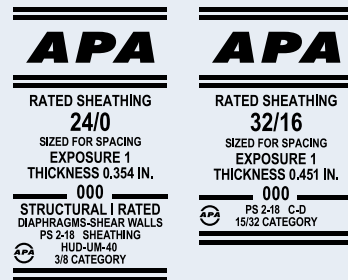

E. Treated Plywood

1. **Fire-retardant-treated plywood**—All plywood shall be pressure-treated in accordance with American Wood Protection Association (AWPA) Standard U1 with an approved (high temperature Interior Type A-HT) (Exterior Type) fire retardant. Each panel shall be labeled or marked by an approved independent testing agency. After treatment, plywood shall be dried to an average moisture content of 15% or less. Plywood shall be all-veneer APA RATED SHEATHING (or better, depending on appearance desired) EXP 1 or EXT.

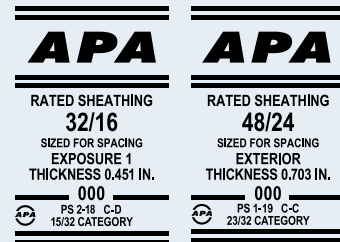

Note: span ratings and load capacities are based on untreated panels and may not apply following fire-retardant treatment (FRT). Obtain structural performance characteristics of FRT panels from the company providing the treatment and redrying service.

2. **Preservative-treated plywood**—Treated plywood for (state application) shall be pressure-treated in accordance with AWPA U1 with (creosote) (pentachlorophenol) (waterborne) preservatives, as required for (coastal water) (wood foundation) (ground contact) (above ground) exposure. Plywood treated with waterborne preservatives shall be dried after treatment to a moisture content of 18% or less.

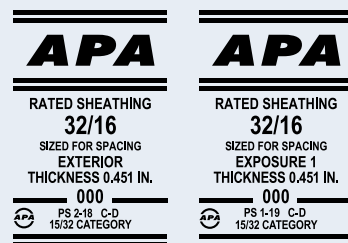

Notes to Panel Specification Guide on page 24.

All treated plywood used in the Permanent Wood Foundation System (PWF) shall be marked PS 1, PS 2 or ANSI APA PRP-210, and marked by an approved inspection agency certified to inspect preservative-treated wood, indicating compliance with the treating, drying, retention and penetration requirements of AWWA Standard U1, or equivalent code-approved preservative-treating and quality control requirements. The mark shall also identify the intended use as Permanent Wood Foundation material.

Plywood shall be all-veneer APA RATED SHEATHING (or better, depending on appearance desired) EXP 1 or EXT.

F. Glued Plywood Components

- General**—All plywood components shall be fabricated in accordance with the appropriate APA Fabrication Specification.¹⁹ Each original plywood panel shall bear the appropriate trademark of APA. Glue shall be of resorcinol or phenolic resin base (for outdoor exposure), or casein with a mold inhibitor (for indoor exposure).

CSI* DIVISION 7—THERMAL AND MOISTURE PROTECTION

A. Siding

Siding shall be (specify appropriate grade):²⁰

APA RATED SIDING EXT, or

APA MEDIUM DENSITY OVERLAY (MDO) GENERAL EXT.

Spacing of 1/8" is recommended at panel ends and edges, unless otherwise indicated by the panel manufacturer. Unless special nail provisions are required (e.g., high wind areas), nail panel siding 6" o.c. along panel edges and 12" o.c. at intermediate supports with 6d nonstaining²¹ box, casing or siding nails for panels with a Performance Category of 1/2 and smaller and 8d for greater Performance Category.^{10,13}

Unless special nail provisions are required (e.g., high wind areas), fasten lap siding installed over panel or lumber sheathing 8" o.c. along bottom edge or as otherwise recommended by manufacturer. Nail lap siding installed direct to studs or over nonstructural sheathing at each stud. Use 6d nonstaining²¹ box, casing or siding nails for siding with a Performance Category of 1/2 or smaller and 8d for thicker panels²². If siding is applied over nonstructural sheathing, use next larger nail size. Use nonstaining box nails for siding installed over foam insulation sheathing, ensuring adequate penetration into the studs to resist wind loads. Prior to installing siding, apply weather-resistant barrier (e.g., building paper) over studs or sheathing.⁶

All panel edges should be sealed. For panels to be painted, sealer can be paint primer; for panels to be stained, sealer should be a water-repellent preservative compatible with the finish.

B. Soffits

Soffits shall be (specify appropriate grade):⁵

APA A-C EXT

APA B-C EXT

APA C-C P&TS EXT

APA RATED SIDING 303 EXT,²⁰ or

APA MEDIUM DENSITY OVERLAY (MDO) GENERAL EXT.²²

Unless special nail provisions are required (e.g., high wind areas), nail 6" o.c. at supported panel edges and 12" o.c. at intermediate supports, with 6d nonstaining²¹ box, casing or siding nails for panels with a Performance Category of 1/2 and smaller, and 8d for Performance Categories up to 3/4.¹³

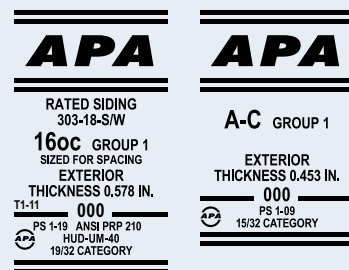
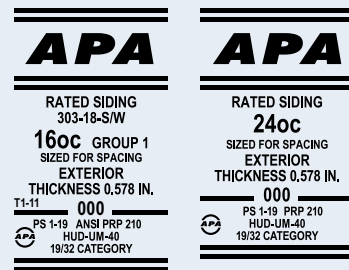

*Construction Specifications Institute

Notes to Panel Specification Guide on page 24.

CSI* DIVISION 9— FINISHES (PAINTING)²⁰

A. Preparation of Surfaces

1. **Exterior Panels**—Panels to be exposed outdoors shall have all edges sealed. With paint, sealer may be a liberal coat of exterior house paint primer. With stain, seal with water-repellent preservative compatible with finish coat.

Surface shall be clean, dry and free of loose wood fibers.

2. **Interior Panels**—Surface shall be clean, dry and free of loose wood fibers. Holes and cracks shall be filled with putty or plastic wood (except for rustic type panels intended for stain finish). After dry, sand lightly in the direction of the grain of face veneer or texture to match existing surfaces.

Any tree pitch or sap spots shall be first touched up with a sealer.

B. Application of Finish

(Specify by brush, roller or spray; brush application of the first coat gives best performance.)

Exterior Panels, Painted—

First coat: Exterior stain-blocking primer as recommended by manufacturer of finish coat. (May be tinted.) Apply quantity as recommended by paint manufacturer.

Second coat: Top-quality exterior all-acrylic latex house paint designed for use with primer; color as selected. Two topcoats provide better performance.

Exterior Panels, Stained—

First coat: Top-quality exterior penetrating semitransparent oil stain where grain showthrough is desired²³ or heavily pigmented solid color oil or latex stain where grain is to be masked;²⁴ color as selected. Apply in one or two coats as recommended by manufacturer.

Use stain-blocking primer with light-colored solid-color latex stains.

Interior Panels, Painted—

First coat: Stain-blocking primer as recommended by manufacturer of finish coat.

Second coat: Flat, semi-gloss or gloss topcoat designed for use with primer; color as selected. Use two topcoats if needed to cover.

Interior Panels, Color Tone—

First coat: Stain and companion sealer mixed to selected color (or sealer, then stain applied separately).

Second coat: Interior satin varnish (additional coats can be applied as desired for depth of luster).

Interior Panels, Light Stain—

First coat: Pigmented resin sealer (wiped off when tacky).

Second coat: Clear resin sealer.

Third coat: Tinted undercoat, thin enamel, pigmented sealer or light stain applied thinly and wiped to the desired color depth; color as selected.

Fourth coat: Interior satin varnish (additional coats can be applied as desired for depth of luster).

*Construction Specifications Institute

Notes to Panel Specification Guide on page 24.

Notes to Panel Specification Guide:

1. The APA trademarks shown here are typical examples only. Refer to the following sections for specific panel grade and thickness recommendations.
2. Structural I grade (all plies limited to Group 1 species) can be specified when greater stiffness or strength is required.
3. Performance Category recommendations are contained in *APA Design/Construction Guide: Concrete Forming, Form V345*.
4. Exposure 1 may be specified for applications where temporary exposure to the weather will be required.
5. Open soffits or roof sheathing exposed on the underside may be any panel classed Exposure 1 where appearance is not a major consideration.
6. Refer to the appropriate application recommendations in this brochure.
7. References to APA's recommendations may allow subsequent specification concerning nailing, edge support and panel orientation to be omitted.
8. Long dimension of panel may be parallel to supports if panel has adequate thickness. See Table 36 for roof panels applied parallel to supports.
9. Supported panel joints shall occur approximately along the centerline of framing with a minimum bearing of 1/2".
10. Engineered shear walls and diaphragms may require additional nailing. See recommendations in Tables 23 and 40. Diagonal bracing is not required for braced wall sections when panel wall sheathing or panel siding (APA RATED SIDING) is used.
11. Other code-approved fasteners may be used.
12. Fasteners shall be located 3/8" from panel edges.
13. See Table 6, page 17, for nail dimensions.
14. Specify veneer-faced STURD-I-FLOOR with "sanded face" when resilient flooring is to be applied (or see note 17 for additional grades). Otherwise, an additional layer of "sanded face" underlayment is recommended when resilient flooring is to be applied over STURD-I-FLOOR.
15. This step may not be necessary under some carpet and structural flooring products—check with flooring manufacturer.
16. Some local building codes accept 12" spacing with glue, but current IBC and IRC require 6" fastener spacing at edges. When panels with a Performance Category greater than 3/4 are used in glued floors, use same fastener schedule as for nailed-only construction.
17. For areas to be covered with resilient flooring or fully adhered carpeting, specify Underlayment or C-C Plugged panel grades marked "sanded face." Underlayment A-C, Underlayment B-C, Marine EXT or sanded plywood grades marked "Plugged Crossbands Under Face," "Plugged Crossbands (or Core)," "Plugged Inner Plies" or "Meets Underlayment Requirements" may also be used under resilient flooring or fully adhered carpeting.
18. For panels with a Performance Category of 1/4, nail 3" o.c. along panel edges and 6" o.c. each way throughout remainder of panel, with 3d ring-shank nails. See Table 17 for underlayment recommendations.
19. Design and fabrication specifications for plywood box beams, stressed-skin panels, curved panels, sandwich panels and all-plywood beams are available from APA.
20. See *APA Product Guide: Performance Rated Siding, Form E300*.
21. Hot-dip or hot-tumbled galvanized steel nails are recommended for most siding applications. For best performance, stainless steel nails or aluminum nails should be considered. APA tests also show that electrically or mechanically galvanized steel nails appear satisfactory when plating meets or exceeds thickness requirements of ASTM A641 Class 2 coatings and is further protected by yellow chromate coating.
Note: Galvanized fasteners may react under wet conditions with the natural extractives of some wood species and may cause staining if left unfinished. Such staining can be minimized if the siding is finished in accordance with APA recommendations or if the roof overhang protects the siding from direct exposure to moisture and weathering.
22. Specify MDO plywood with one face of Medium Density Overlay as described in Voluntary Product Standard PS 1.
23. Semitransparent stains may be used on plywood face grades 303-OC, 303-NR and 303-6-W. Other 303 face grades should not be finished with semitransparent stains unless specifically recommended by the panel manufacturer.
24. Only latex formulations are recommended on APA 303-SR and 303-NR grades of plywood siding.



GLULAM SELECTION AND SPECIFICATION

Glued laminated timber (glulam) is made up of wood laminations, or “lams,” that are bonded together with adhesives. The grain of all laminations runs parallel with the length of the member. Individual lams typically are 1-3/8 inches thick for southern pine and 1-1/2 inches thick for western species, although other thicknesses may also be used. Glulam products typically range in net widths from 2-1/2 to 10-3/4 inches, although virtually any width can be produced.

Balanced and Unbalanced Beams

Glulam may be manufactured as unbalanced or balanced members.

The most critical zone of a glulam bending member with respect to controlling strength is the outermost tension zone. In unbalanced beams, the quality of lumber used on the tension side of the beam is higher than the lumber used on the corresponding compression side, allowing a more efficient use of the timber resource. Therefore, unbalanced beams have different bending stresses assigned to the compression and tension zones and must be installed accordingly. To assure proper installation of unbalanced beams, the top of the beam is clearly stamped with the word “TOP.” Unbalanced beams are primarily intended for simple-span applications even though they can also be used in multiple-span applications when properly designed.

Balanced members are symmetrical in lumber quality about the mid-depth. Balanced beams are used in applications such as long cantilevers or continuous spans, where either the top or bottom of the member may be highly stressed in tension due to service loads. They can also be used in single-span applications, although an unbalanced beam is more cost-efficient for this use.

Allowable Design Properties

Allowable design properties are a key factor in specifying glulam. Bending members are typically specified on the basis of the maximum allowable bending stress of the member. For example, a 24F designation indicates a member with an allowable bending stress of 2400 psi. Similarly, a 30F designation refers to a member with an allowable bending stress of 3000 psi. These different stress levels are achieved by varying the species and percentages and grade of higher quality lumber in the beam layup.

To identify whether the lumber used in the beam is visually or mechanically graded, the stress combination also includes a second set of designations. For example, for an unbalanced 24F layup using visually graded lumber, the layup designation may be identified as a 24F-V4. The “V” indicates that the layup uses visually graded lumber. (“E” is used for E-rated or mechanically graded lumber.) The number “4” further indicates a specific combination of lumber used, to which a full set of design stresses, such as horizontal shear, MOE, etc., are assigned. The glulam industry has introduced the concept of specifying glulam based on a stress class system similar to that used for MSR lumber or SCL. This requires only specifying an F_b -E value. Typical stress classifications are in Table 9. See also ANSI 117, *Standard Specification for Structural Glued Laminated Timber of Softwood Species*, published by APA.

Sizes

Glulam is available in both custom and stock sizes. Stock beams are manufactured in commonly used dimensions and cut to length when the beam is ordered from a distributor or dealer. Typical stock beam widths used in residential construction include: 3-1/8, 3-1/2, 5-1/8, 5-1/2 and 6-3/4 inches.

For nonresidential applications, where long spans, unusually heavy loads or other circumstances control design, custom members are typically specified. Common custom shapes include straight beams, curved beams, pitched and curved beams, radial arches and tudor arches.

Appearance Classification

Glulam is available in a range of appearances, all having the same structural characteristics for a given strength grade. Glulam appearance classifications are:

Framing. A classification that denotes the member is intended only for use in concealed applications. Beams with this appearance classification are provided in widths designed to fit flush with 2x4 and 2x6 wall framing. Framing-L is the same as Framing but denotes that LVL has been used for the outer tension laminations.

Industrial. Used for concealed applications or where appearance is not of primary importance. Industrial-L is the same as Industrial but denotes that LVL has been used for outer tension laminations.

Architectural. The appearance of choice in applications where members are exposed to view, because they have a smooth, attractive finish. Stock beams are often supplied with this appearance classification so they may be exposed to view in the finished structure.

Premium. Available only as a custom order where finished appearance is of primary importance.

All appearance classifications permit natural growth characteristics with varying degrees of open voids. Voids are filled as required by the appearance classification specified using inserts and wood fillers. The appearance classification is not related to lumber layup requirements and thus does not affect design values for the beam. For additional information, refer to ANSI A190.1, *Standard for Wood Products – Structural Glued Laminated Timber*, or APA *Technical Note: Glulam Appearance Classifications for Construction Applications*, Form Y110.

STANDARD BEAM LAYUP

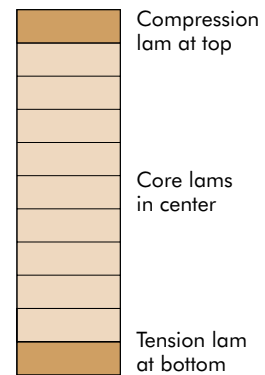

TABLE 9

**REFERENCE DESIGN VALUES FOR STRUCTURAL GLUED LAMINATED SOFTWOOD TIMBER
(Members stressed primarily in bending)**

(Tabulated design values are for normal load duration and dry service conditions.)

| Stress Class | Bending About X-X Axis Loaded Perpendicular to Wide Faces of Laminations | | | | | | |
|----------------------------|--|--|------------------------------------|-------------------------|------------------------------------|-----------------------------------|-----------------------------------|
| | Extreme Fiber in Bending | | | | Modulus of Elasticity | | |
| | Bottom of Beam Stressed in Tension (Positive Bending) | Top of Beam Stressed in Tension (Negative Bending) | Compression Perpendicular to Grain | Shear Parallel to Grain | For Deflection Calculations | | For Stability Calculations |
| | F_{bx}^+ (psi) | F_{bx}^- (psi) | F_{cLx} (psi) | $F_{vx}^{(d)}$ (psi) | E_x^{true} (10 ⁶ psi) | E_x^{app} (10 ⁶ psi) | E_x^{min} (10 ⁶ psi) |
| 16F-1.3E | 1600 | 925 | 315 | 195 | 1.4 | 1.3 | 0.69 |
| 20F-1.5E | 2000 | 1100 | 425 | 195 ^f | 1.6 | 1.5 | 0.79 |
| 24F-1.7E | 2400 | 1450 | 500 | 210 ^f | 1.8 | 1.7 | 0.90 |
| 24F-1.8E | 2400 | 1850 ^b | 650 | 265 ^c | 1.9 | 1.8 | 0.95 |
| 26F-1.9E ^g | 2600 | 1950 | 650 | 265 ^c | 2.0 | 1.9 | 1.00 |
| 28F-2.1E SP ^a | 2800 | 2300 | 805 | 300 | 2.2 ⁱ | 2.1 ⁱ | 1.09 |
| 30F-2.1E SP ^{a,h} | 3000 | 2400 | 805 | 300 | 2.2 ⁱ | 2.1 ⁱ | 1.09 |

- a. For balanced layups, F_{bx}^- shall be equal to F_{bx}^+ for the stress class. Designer shall specify when balanced layup is required.
- b. Negative bending stress, F_{bx}^- , is permitted to be increased to 1950 psi for southern pine for specific combinations. Designer shall specify when these increased stresses are required.
- c. For structural glued laminated timber of southern pine, the basic shear design values, F_{vx} and F_{vy} , are permitted to be increased to 300 psi and 260 psi, respectively.
- d. The design values for shear, F_{vx} and F_{vy} , shall be decreased by multiplying by a factor of 0.72 for non-prismatic members, notched members and for all members subject to impact or cyclic loading. The reduced design value shall be used for design of members at connections that transfer shear by mechanical fasteners. The reduced design value shall also be used for determination of design values for radial tension and torsion.
- e. Design values are for timbers with laminations made from a single piece of lumber across the width or multiple pieces that have been edge-bonded. For timbers manufactured from multiple piece laminations (across width) that are not edge-bonded, value shall be multiplied by 0.4 for members with 5, 7, or 9 laminations or by 0.5 for all other members. This reduction shall be cumulative with the adjustment in footnote d.

Continued on next page

TABLE 9 (Continued)

**REFERENCE DESIGN VALUES FOR STRUCTURAL GLUED LAMINATED SOFTWOOD TIMBER
(Members stressed primarily in bending)**

(Tabulated design values are for normal load duration and dry service conditions.)

| Stress Class | Bending About Y-Y Axis Loaded Parallel to Wide Faces of Laminations | | | | | | Axially Loaded | Fasteners | |
|----------------------------|--|--|--|--|--|--|---|--|---|
| | Extreme Fiber in Bending F_{by} (psi) | Compression Perpendicular to Grain F_{cLy} (psi) | Shear Parallel to Grain F_{vy} ^(e) (psi) | Modulus of Elasticity | | For Stability Calculations $E_{y\min}$ (10 ⁶ psi) | Tension Parallel to Grain F_t (psi) | Com- pression Parallel to Grain F_c (psi) | Specific Gravity for Fastener Design G |
| | | | | For Deflection Calculations $E_{y\text{true}}$ (10 ⁶ psi) | For Stability Calculations $E_{y\text{app}}$ (10 ⁶ psi) | | | | |
| 16F-1.3E | 800 | 315 | 170 | 1.2 | 1.1 | 0.58 | 675 | 925 | 0.41 |
| 20F-1.5E | 800 | 315 | 170 | 1.3 | 1.2 | 0.63 | 725 | 925 | 0.41 |
| 24F-1.7E | 1050 | 315 | 185 | 1.4 | 1.3 | 0.69 | 775 | 1000 | 0.42 |
| 24F-1.8E | 1450 | 560 | 230 ^c | 1.7 | 1.6 | 0.85 | 1100 | 1600 | 0.50 ^l |
| 26F-1.9E ^g | 1600 | 560 | 230 ^c | 1.7 | 1.6 | 0.85 | 1150 | 1600 | 0.50 ^l |
| 28F-2.1E SP ^g | 1600 | 650 | 260 | 1.8 | 1.7 | 0.90 | 1250 | 1750 | 0.55 |
| 30F-2.1E SP ^{g,h} | 1750 | 650 | 260 | 1.8 | 1.7 | 0.90 | 1250 | 1750 | 0.55 |

f. Certain southern pine combinations may contain lumber with wane. If lumber with wane is used, the design value for shear parallel to grain, F_{vy} , shall be multiplied by 0.67 if wane is allowed on both sides. If wane is limited to one side, F_{vy} shall be multiplied by 0.83. This reduction shall be cumulative with the adjustment in footnote d.

g. 26F, 28F and 30F beams are not produced by all manufacturers, therefore, availability may be limited. Contact supplier or manufacturer for details.

h. 30F combinations are restricted to a maximum 6 in. nominal width unless the manufacturer has qualified for wider widths based on full-scale tests subject to approval by an accredited product certification agency.

i. For 28F and 30F members with more than 15 laminations, $E_{x\text{true}} = 2.1 \times 10^6$ psi, $E_{x\text{app}} = 2.0 \times 10^6$ psi and $E_{x\min} = 1.06 \times 10^6$ psi.

j. For structural glued laminated timber of southern pine, specific gravity for fastener design is permitted to be increased to 0.55.

Design values in this table represent design values for groups of similar glued laminated timber combinations. Higher design values for some properties may be obtained by specifying a particular combination in ANSI 117. Design values are for members with 4 or more laminations. Some stress classes are not available in all species. Contact supplier or manufacturer for availability.

Section Properties and Capacities

When selecting a glulam member, the builder, designer or specifier must use a member with the required section properties and the applicable design values to satisfy the load carrying requirements. Different load capacities are possible for different stress level combinations of glulam. Tables giving the load carrying capacities for glulam are included in the *APA Data File: Glued Laminated Beam Design Tables, Form S475*.

Camber

Camber is curvature built into a fabricated member (see figure at right) which is opposite in direction to the calculated deflection which will occur under gravity loads.

The glulam industry recommends that roof beams be cambered for 1.5 times the calculated dead load deflection. This will generally be sufficient to assure that the beam will not visibly sag over a period of many years of loading, as may occur with non-cambered wood products. To achieve a level profile, it is recommended that floor beams be only cambered for 1.0 times the calculated dead load deflection.

Camber for glulam beams is specified as either “inches of camber” or as a radius of curvature that is to be used in the manufacturing process. Commonly used curvature radii for commercial applications are 1,600 and 2,000 feet, although any camber may be specified.

Most residential applications require very little or no camber which, in turn, makes glulam the ideal choice. Stock beams are typically supplied with a relatively flat camber radius of 5,000 feet as shown in Table 10, or zero camber. Thus they have just the right camber for residential construction. If, however, more camber is required, such as for a long-span roof beam, custom beams are available through manufacturers to meet the most exacting specifications.

For additional information on cambering glulam beams, refer to *APA Technical Note: Glulam Beam Camber, Form S550*, which provides a camber table for various beam spans and radii of curvature.

BEAM CAMBER PARAMETERS

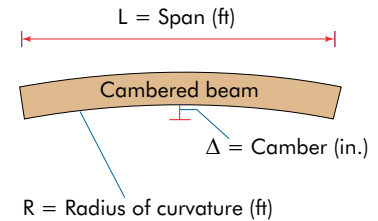

TABLE 10

CAMBER FOR 5,000-FOOT RADIUS

| Span in feet: | 10 | 12 | 14 | 16 | 18 | 20 | 22 | 24 | 26 | 28 |
|-----------------|------|------|------|------|------|------|------|------|------|------|
| Camber in inch: | 0.03 | 0.04 | 0.06 | 0.08 | 0.10 | 0.12 | 0.15 | 0.17 | 0.20 | 0.24 |

Trademarks and Acceptance

Glulam beams manufactured by APA members are certified with the APA trademark. The mark (as shown) signifies that the manufacturer is committed to a rigorous program of quality verification and testing and that products are manufactured in conformance with ANSI A190.1, *Standard for Wood Products – Structural Glued Laminated Timber*. The APA trademark is recognized by all major model building codes.

Typical information included in an APA trademark is shown at right. This information may vary depending on whether the member is supplied as a custom or stock product.

Glulam Beam Storage and Handling

APA trademarked glulam beams are commonly protected with sealants, primers or wrappings when they leave the mill. But care must be taken during loading, unloading and transporting, as well as in the yard and on the job site.

Sealants on the ends of beams help guard against moisture penetration and checking. Apply a coat of sealant to the ends of beams after trimming. Surface sealants, which can be applied to the top, bottom and sides of beams, resist dirt and moisture and help control checking and grain raising. Use a penetrating sealant if beams will be stained or given a natural finish.

A primer coat also protects beams from moisture and dirt and provides a paintable surface.

Water-resistant wrappings are another way to protect beams from moisture, dirt and scratches. Because sunlight can discolor beams, opaque wrappings are recommended. Beams can be wrapped individually, by the bundle or by the load. In situations where appearance is especially important, the wrapping can be removed after installation to avoid damage.

If possible, store glulam under cover to protect them from rain and sunlight. Place the beams on spaced lumber bunks on level, well-drained ground. In some instances, the wrappings can be used to protect beams until installation. Again, seal ends of beams immediately after trimming. Once beams are installed, allow them to gradually season and adjust to the temperature and moisture conditions of the structure.

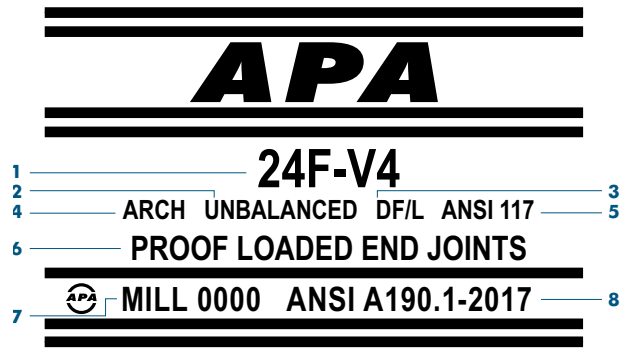

1. Combination symbol.
2. Unbalanced layout.
3. The species or species group of lumber used.
4. Designation of appearance classification.
5. Applicable design and manufacturing specification.
6. Indicates the member has the required laminations proof loaded.
7. Mill number.
8. Identification of ANSI A190.1, the *Standard for Wood Products – Structural Glued Laminated Timber*.

GLULAM BEAM STORAGE

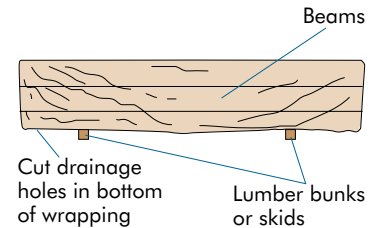

Glulam Specification Guide

The following is a guide for preparing specifications for structural glued laminated timber used for bending members such as purlins, beams or girders or for axially loaded members such as columns or truss chords.

A. General

1. Structural glued laminated timber shall be furnished as shown on the plans and in accordance with the following specifications. (Where other uses or requirements are applicable, modify specifications accordingly.)
2. For custom designed members, shop drawings and details shall be furnished by the (manufacturer) (seller) and approval obtained from the (architect) (engineer) (general contractor) (buyer) before fabrication is begun.
3. The (manufacturer) (seller) (general contractor) shall furnish connection steel and hardware for joining structural glued laminated timber members to each other and to their supports, exclusive of anchorage embedded in masonry or concrete, setting plates and items field-welded to structural steel. Steel connections shall be finished with a minimum of one coat of rust-inhibiting paint.

B. Manufacture

1. **Materials, Manufacture and Quality Assurance**—Structural glued laminated timber of softwood species shall be in conformance with ANSI A190.1, *Standard for Wood Products – Structural Glued Laminated Timber*, or other code-approved design, manufacturing and/or quality assurance procedures.
2. **End-Use Application**—Structural glued laminated timber members shall be manufactured for the following structural uses as applicable: (Simple span bending member—B) (continuous or cantilever span bending member—CB) (compression member—C) (tension member—T).
3. **Design Values**—Structural glued laminated timber shall provide design values for normal load duration and dry-use condition.^{1,2} The design should specify a layup combination from ANSI 117 or specify a stress class from Table 9.
4. **Appearance Classification**—Structural glued laminated timber shall be (framing) (framing-L) (industrial) (industrial-L) (architectural) (premium) classification³ in accordance with ANSI A190.1.
5. **Laminating Adhesives**—Adhesives used in the manufacture of structural glued laminated timber shall meet requirements for (wet-use) (dry-use) service conditions.¹
6. **Camber (when applicable)**—Structural glued laminated timber (shall) (shall not) be manufactured with a built-in camber.
7. **Preservative Treatment (when applicable)**—Structural glued laminated timber shall be pressure treated after manufacture in accordance with American Wood Protection Association (AWPA) Standard U1 with (creosote or creosote/coal tar solution) (pentachlorophenol in oil) (pentachlorophenol in light solvent) (copper naphthenate) preservatives as required for (soil contact) (above ground) exposure.⁴
8. **Fire Resistance (when applicable)**—Structural glued laminated timber shall be sized and manufactured for one-hour fire resistance.⁵ The use of pressure impregnated fire retardant treatments is not recommended.
9. **Protective Sealers and Finishes**—Unless otherwise specified, sealer shall be applied to the ends of all members. Surfaces of members shall be (not sealed) (sealed with penetrating sealer) (sealed with primer/sealer coating).⁶
10. **Trademarks**—Members shall be marked with the APA trademark indicating conformance with the manufacturing, quality assurance and marking provisions of ANSI A190.1.
11. **Certificates (when applicable)**—A Certificate of Conformance may be provided by the (manufacturer) (seller) to indicate conformance with ANSI A190.1 if requested.
12. **Protection for Shipment**—Members shall be (not wrapped) (load wrapped) (bundle wrapped) (individually wrapped) with a water-resistant covering for shipment.

Notes to Glulam Specification Guide:

1. **Dry service condition**—average equilibrium moisture content of the member will be below 16% in service; **wet service condition**— average equilibrium moisture content of the member will be at or above 16% in service. When structural glued laminated timber members are to be preservative treated, wet-use adhesives must be specified.
2. An alternative to specifying a layup combination or stress class is to specify the required allowable design stresses for the specific design application.
3. Appearance classifications are described in ANSI A190.1 or *APA Technical Note: Glulam Appearance Classifications for Construction Applications*, Form Y110.
4. See *APA Technical Note: Preservative Treatment of Glued Laminated Timber*, Form S580.
5. When structural glued laminated timber with one-hour fire resistance is specified, minimum size limitations and additional lamination requirements are applicable. Supporting steel connectors and fasteners also must be protected to achieve a one-hour fire rating. Cover with fire-rated (Type X) gypsum wallboard or 1-1/2" wood to provide the needed protection.
6. Specify a penetrating sealer when the finish will be natural or a semitransparent stain. Primer/sealer coatings have a higher solids content, provide greater moisture protection and are suitable for use with opaque or solid-color finishes.



Photo courtesy of Structurlam Products Ltd.

CROSS-LAMINATED TIMBER SELECTION AND SPECIFICATION

Cross-laminated timber (CLT) is a prefabricated, solid engineered mass timber panel. CLT is manufactured with kiln-dried lumber boards or structural composite lumber (SCL) laminated in alternating directions and bonded with structural adhesives to form a solid, straight, rectangular panel. The panels are comprised of an odd number of layers, usually three to seven. CLT's panel size varies by manufacturer, but typical widths are 2 feet, 4 feet, 8 feet and 10 feet, with a thickness of 20 inches or less and a length of up to 60 feet.

Applications

CLT is frequently used in multistory mass timber structures, with concrete podiums and other types of buildings. CLT may be used in the construction of a wide variety of structural elements, such as structural and non-structural wall elements; floor/ceiling, parapet wall and roof elements; pre-insulated wall and roof sections; and solid partitions with or without interior finishes. Other applications include cantilevered floors/balconies, load-bearing elevator shafts and stairs.

Advantages

CLT is a structural wood product that offers fast construction times. Because CLT is prefabricated, most components arrive ready to assemble and go together very quickly. CLT's large-scale components enable faster construction, not only because of prefabrication, but because fewer joints are needed between elements. CLT is very strong: the cross-wise arrangement of board layers lends integral structural stability to the panel, considerably increases dimensional stability and ensures uniform load transfer to all sides for excellent structural capacities. CLT's high load-bearing properties also extend its applicability to the construction of bridges, carports, ancillary buildings, wood/concrete composite ceilings and others.

Allowable Design Capacities

There are five basic "E" grades, six "V" grades and three "S" grades for CLT products and layups. "E", "V" and "S" indicate a CLT grade with layup of E-rated or machine stress rated (MSR) laminations, visually graded laminations or structural composite lumber (SCL) in the longitudinal layers, respectively. Visually graded or SCL laminations are used in the transverse layers for both "E" and "V" grades and "S" grades, respectively. Custom layups of CLT are also permitted, as stipulated in ANSI/APA PRG 320, *Standard for Performance-Rated Cross-Laminated Timber*.

The allowable stress design (ASD) reference design capacities for CLT grades with layups of three, five and seven layers are shown in ANSI/APA PRG 320. The ASD reference design capacities for different CLT products, including custom grades and layups, are typically published in APA Product Reports (www.apawood.org/product-reports) or manufacturers' literature.

Trademarks and Acceptance

Chapter 10 of the 2018 *National Design Specification*® (NDS) provides design procedures, reference design values and other information for CLT, while engineering design of connections using dowel-type fasteners in CLT is covered in Chapter 12 of the 2018 NDS. Sections were also added to the 2018 and 2015 IBC and IRC regarding CLT used as different structural elements. Clause 8 in the Canadian Standards Association CSA O86-19 provides design procedures, resistance values and other information for CLT used in Canada.

Laminations

Any softwood lumber species or species combinations recognized by American Lumber Standards Committee under PS 20 or Canadian Lumber Standards Accreditation Board under CSA O141 with a minimum published specific gravity of 0.35 are permitted for use in CLT, provided that other requirements specified in ANSI/APA PRG 320 are satisfied. SCL should meet the requirements of ASTM D5456, *Standard Specification for Evaluation of Structural Composite Lumber Products*, and have an “equivalent specific gravity” of 0.35 or higher.

Lumber grades are required to be at least 1200f-1.2E MSR or visually graded No. 2 in the longitudinal layers and visual graded No. 3 in the transverse layers.

Moisture content is required to be $12 \pm 3\%$ for lumber and $8 \pm 3\%$ for SCL at the time of CLT manufacturing unless a lower moisture content is specifically qualified in accordance with the standard.

Adhesives

In the U.S., adhesives used for CLT manufacturing are required to meet ANSI 405, *Standard for Adhesives for Use in Structural Glued Laminated Timber*, with the exception that some gluebond durability tests are not required. This is because CLT manufactured according to ANSI/APA PRG 320 is limited to dry service conditions, and some gluebond durability tests are designed for adhesives in exterior applications. In Canada, CLT adhesives must meet the requirements of CSA O112.10. In both the U.S. and Canada, CLT adhesives must meet ASTM D7247 for heat durability and CSA O177, small-scale flame test. In addition, CLT adhesives must comply with the requirements for elevated temperature performance in accordance with the full-scale compartment fire test specified in Annex B of ANSI/APA PRG 320.

Note: *National Design Specification*® is a registered trademark of the American Wood Council.



1. Grade qualified in accordance with ANSI/APA PRG 320.
2. Product thickness.
3. APA mill number.
4. Referenced product standard.

Cross-Laminated Timber (CLT) Specification Guide

A. General

CLT shall be furnished and installed in accordance with the recommendations provided by the CLT manufacturer and the engineering drawing approved by the engineer of record. Permissible details shall be in accordance with the engineering drawing.

B. Manufacture

1. **Materials, Manufacture and Quality Assurance**—Product quality shall conform to ANSI/APA PRG 320, *Standard for Performance-Rated Cross-Laminated Timber*.
2. **Trademarks**—CLT products conforming to ANSI/APA PRG 320, *Standard for Performance-Rated Cross-Laminated Timber*, shall be marked with CLT grade, CLT thickness or identification, mill name or identification number, the APA logo and “ANSI/APA PRG 320.” The top face of custom CLT panels with unbalanced layup used for roof or floor shall be marked with “TOP” stamp.
3. **Protection for Shipment**—Members shall be protected with a water-resistant covering for shipment.

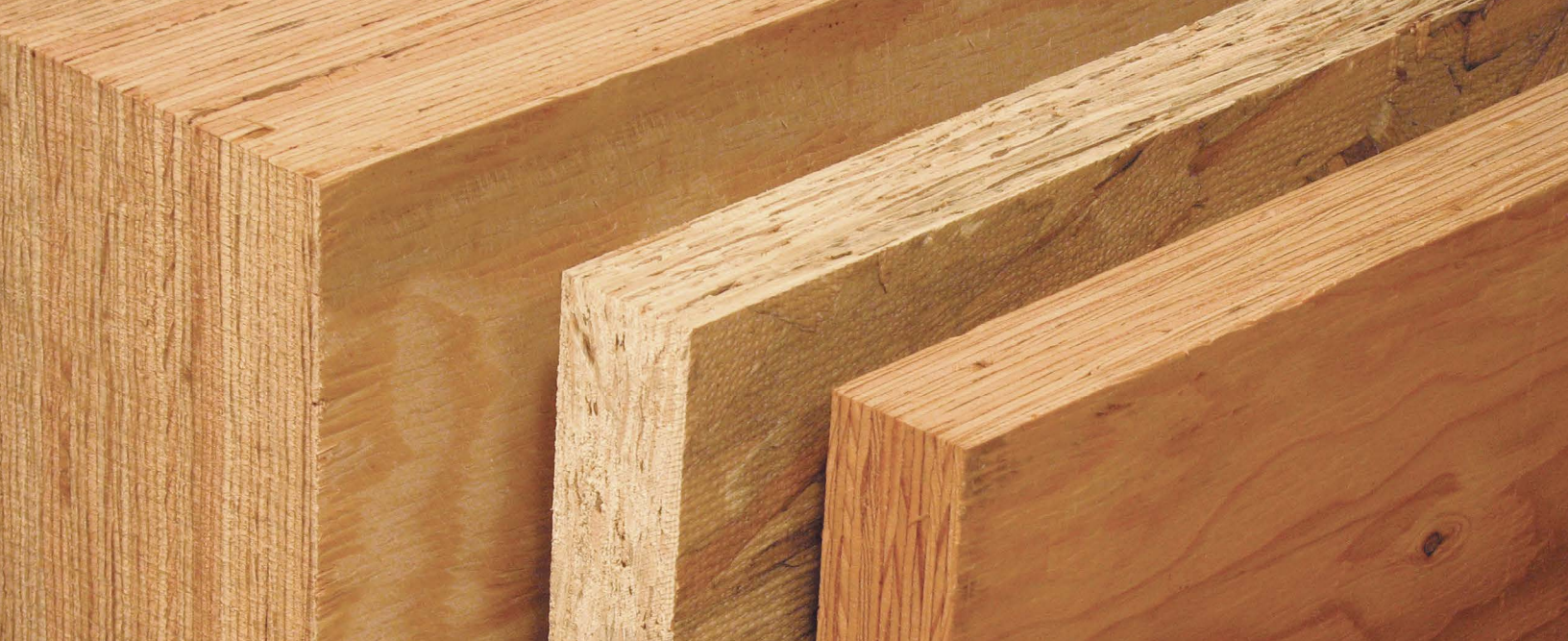

STRUCTURAL COMPOSITE LUMBER SELECTION AND SPECIFICATION

Structural composite lumber (SCL), which includes laminated veneer lumber (LVL), parallel strand lumber (PSL), laminated strand lumber (LSL) and oriented strand lumber (OSL), is a family of engineered wood products created by layering dried and graded wood veneers, strands or flakes with moisture-resistant adhesive into blocks of material known as billets, which are subsequently resawn into specified sizes. A brief description of each product is as follows:

Laminated Veneer Lumber (LVL)

LVL is the most widely used of the structural composite lumber products. It is produced by bonding thin wood veneers together in a large billet. The grain of all veneers is parallel to the long direction. The LVL billet is then sawn to desired dimensions depending on the construction application. Some of the products' many uses are headers and beams, hip and valley rafters, scaffold planking and the flange material for prefabricated wood I-joists. Because LVL is made with scarfed or lapped jointed veneers, it is available in lengths far beyond conventional lumber lengths.

Parallel Strand Lumber (PSL)

PSL is manufactured from veneers clipped into long strands laid in parallel formation and bonded together with an adhesive to form the finished structural section. The length-to-thickness ratio of the strands in PSL is around 300. Like LVL and glulam, this product is used for beam and header applications where high bending strength is needed. PSL is also frequently used as load-bearing columns.

Laminated Strand Lumber (LSL)

Laminated strand lumber is made from flaked wood strands that have a length-to-thickness ratio of approximately 150. Combined with an adhesive, the strands are oriented and formed into a large mat or billet and pressed. LSL is used in a variety of applications from studs to millwork components.

Oriented Strand Lumber (OSL)

Oriented strand lumber is made from flaked wood strands. The strand geometry for OSL results in length-to-thickness ratios of approximately 75. Combined with an adhesive, the strands are oriented and formed into a large mat or billet and pressed. OSL is used in a variety of applications from studs to millwork components.

In SCL billets, the grain of each layer of veneer or flakes runs primarily in the same direction. The resulting products out-perform conventional lumber when either face- or edge-loaded. SCL is a solid, highly predictable and uniform engineered wood product that is sawn to consistent sizes and is virtually free from warping and splitting.

Typical uses for SCL include rafters, headers, beams, joists, studs and columns. Two or three sections of SCL can be joined together to form 3-1/2-inch or 5-1/4-inch thick members. These thicker sections readily nest into 2x4 or 2x6 framed walls as headers or columns.

Allowable Strength Properties

Structural properties of SCL are evaluated using methods specified in ASTM D5456, *Standard Specification for Structural Composite Lumber*. Ongoing quality auditing of SCL is performed by APA. The structural design values for SCL are published on a proprietary basis by SCL manufacturers and are recognized in ICC-ES evaluation reports or APA Product Reports (www.apawood.org/product-reports). A list of APA SCL manufacturers is available on APA's website (www.apawood.org).

SCL Storage and Handling

Care must be taken to protect SCL in all transit periods, from the point where the product is delivered, to job-site handling and storage, to final installation. SCL products are usually shipped in water-resistant wrapping that protects them from moisture, soiling and surface scratches. SCL packages should be set on level, well-drained surfaces. Lumber bumpers or blocks should be used to keep SCL packages from direct contact with the ground. For long-term storage, cut slits in the bottom of the wrapping to allow ventilation and drainage of any entrapped moisture in order to reduce the possibility of water damage, staining or decay. For long storage periods, storing SCL in a covered area is recommended.



1. Qualified SCL grade (usually represented by design values).
2. APA mill number.
3. Product evaluation reports.
4. Standard specification for LVL.

Structural Composite Lumber (SCL) Specification Guide

A. General

1. SCL shall be furnished and installed as shown on the approved building plans and in accordance with the specifications of the SCL manufacturer.
2. The contractor shall use approved hardware and connections as specified in the plans.

B. Manufacture

1. **Materials, Manufacture and Quality Assurance**—Product quality shall conform to the manufacturer's approved quality manual, with quality assurance inspection services provided by APA in accordance with building code requirements and the applicable APA Product Report or code evaluation report.
2. **Trademarks**—SCL shall be marked with the APA trademark, indicating conformance with the manufacturer's APA Product Report or code evaluation report.
3. **Job Site Shipment**—SCL shall be protected from direct exposure to weather prior to installation.
4. **Protection for Shipment**—Members shall be protected with a water-resistant covering for shipment.



I-JOIST SELECTION AND SPECIFICATION

I-joists are “I”-shaped engineered wood structural members designed for use in residential and nonresidential construction. The product is prefabricated using sawn or structural composite lumber flanges and OSB webs, bonded together with exterior type adhesives. To simplify the specification and use of I-joists, APA introduced the APA Performance Rated I-Joist (PRI). The I-joist is limited to a $L/480$ live load maximum deflection (where L = span) for glued-nailed residential floor applications, which provides superior floor performance.

APA Performance Rated I-Joists are identified by their net depth followed by a designation, such as PRI-30, which relates to the joist strength and stiffness. APA PRIs are available in four depths: 9-1/2, 11-7/8, 14 and 16 inches.

Most manufacturers supply I-joists to distributors and dealers in lengths up to 60 feet. These are then cut to frequently used lengths such as 16 to 36 feet. Check local supplier for availability.

APA PRI-400

APA PRIs are manufactured in accordance with *APA Standard PRI-400, Performance Standard for APA EWS I-Joists, Form X720*. This Performance Standard provides an easy-to-use table of allowable spans for applications in residential floor construction, allowing designers and builders to select and use I-joists from various member manufacturers using just one set of span tables. APA PRIs are recognized in ICC-ES ESR-1405.

Residential Floor Spans

Some APA PRIs include in their trademarks allowable spans for uniformly loaded residential floor construction at various I-joist spacings. The specific I-joist needed is easily determined by selecting the span and then choosing the I-joist that meets the span, spacing and loading criteria. See Tables 11 and 12.

For more information on selecting APA I-joists and for design tables, refer to *APA Performance Rated I-Joists, Form Z725*.

I-Joist Storage and Handling

Store, stack and handle I-joists with the webs vertical and keep joists level. Do not store I-joists in direct contact with the ground. Maintain at least 12 inches between the ground and the I-joists. Protect I-joists from weather and use stickers to separate the bundles. If I-joists are delivered wrapped, do not open bundles until time of installation.

TABLE 11

ALLOWABLE SPANS FOR APA EWS PERFORMANCE-RATED I-JOISTS—SIMPLE SPAN ONLY^{a,b,c,d,e}

| Depth | Joist Series | Simple Spans | | | |
|----------|--------------|-------------------|---------|---------|---------|
| | | On Center Spacing | | | |
| | | 12" | 16" | 19.2" | 24" |
| 9'-1/2" | PRI-20 | 16'-2" | 14'-10" | 14'-0" | 13'-1" |
| | PRI-30 | 17'-1" | 15'-7" | 14'-9" | 13'-9" |
| | PRI-40 | 17'-9" | 16'-3" | 15'-4" | 14'-4" |
| | PRI-50 | 17'-10" | 16'-4" | 15'-5" | 14'-5" |
| | PRI-60 | 18'-8" | 17'-1" | 16'-1" | 15'-0" |
| 11'-7/8" | PRI-20 | 19'-3" | 17'-8" | 16'-8" | 15'-7" |
| | PRI-30 | 20'-4" | 18'-7" | 17'-7" | 16'-5" |
| | PRI-40 | 21'-2" | 19'-4" | 18'-3" | 16'-8" |
| | PRI-50 | 21'-2" | 19'-5" | 18'-4" | 17'-1" |
| | PRI-60 | 22'-2" | 20'-3" | 19'-2" | 17'-10" |
| | PRI-70 | 23'-0" | 20'-11" | 19'-9" | 18'-5" |
| | PRI-80 | 24'-6" | 22'-4" | 21'-0" | 19'-7" |
| | PRI-90 | 25'-2" | 22'-11" | 21'-8" | 20'-2" |
| 14" | PRI-40 | 24'-0" | 21'-11" | 20'-6" | 18'-4" |
| | PRI-50 | 24'-1" | 22'-0" | 20'-9" | 19'-5" |
| | PRI-60 | 25'-2" | 23'-0" | 21'-9" | 20'-3" |
| | PRI-70 | 26'-1" | 23'-9" | 22'-5" | 20'-11" |
| | PRI-80 | 27'-9" | 25'-4" | 23'-10" | 22'-2" |
| | PRI-90 | 28'-7" | 26'-0" | 24'-6" | 22'-10" |
| 16" | PRI-40 | 26'-7" | 24'-3" | 22'-1" | 19'-9" |
| | PRI-50 | 26'-8" | 24'-4" | 23'-0" | 20'-2" |
| | PRI-60 | 27'-11" | 25'-6" | 24'-0" | 22'-5" |
| | PRI-70 | 28'-10" | 26'-4" | 24'-10" | 23'-1" |
| | PRI-80 | 30'-9" | 28'-0" | 26'-5" | 24'-7" |
| | PRI-90 | 31'-7" | 28'-9" | 27'-1" | 25'-3" |

- a. Allowable clear span applicable to simple-span residential floor construction with a design dead load of 10 psf and live load of 40 psf. The live load deflection is limited to span/480.
- b. Spans are based on a composite floor with glued-nailed sheathing meeting the requirements for APA Rated Sheathing or APA Rated STURD-I-FLOOR conforming to PS 1, PS 2, CSA O325 or CSA O437 with a minimum 19/32 Performance Category (40/20 or 20 oc) for a joist spacing of 19.2 inches or less, or 23/32 Performance Category (48/24 or 24 oc) for a joist spacing of 24 inches. Adhesive shall meet ASTM D3498 or APA Specification AFG-01. Spans shall be reduced 12 inches when the floor sheathing is nailed only.
- c. Minimum bearing length shall be 1-3/4 inches for the end bearings.
- d. Bearing stiffeners are not required when I-joists are used with the spans and spacings given in this table, except as required by hanger manufacturers.
- e. This span chart is based on uniform loads. For applications with other than uniformly distributed loads, an engineering analysis may be required based on the use of the design properties in Table 7 of *APA Performance Rated I-Joists, Form Z725*.

TABLE 12

ALLOWABLE SPANS FOR APA EWS PERFORMANCE-RATED I-JOISTS—MULTIPLE SPAN ONLY^{a,b,c,d,e}

| Depth | Joist Series | Multiple Spans | | | |
|---------|--------------|-------------------|---------|---------|---------|
| | | On Center Spacing | | | |
| | | 12" | 16" | 19.2" | 24" |
| 9-1/2" | PRI-20 | 17'-7" | 16'-1" | 15'-3" | 13'-5" |
| | PRI-30 | 18'-7" | 17'-0" | 16'-0" | 15'-0" |
| | PRI-40 | 19'-4" | 17'-8" | 16'-4" | 14'-7" |
| | PRI-50 | 19'-5" | 17'-9" | 16'-9" | 15'-7" |
| | PRI-60 | 20'-4" | 18'-7" | 17'-6" | 16'-4" |
| 11-7/8" | PRI-20 | 21'-0" | 19'-2" | 16'-9" | 13'-5" |
| | PRI-30 | 22'-1" | 20'-3" | 18'-10" | 15'-0" |
| | PRI-40 | 23'-0" | 20'-5" | 18'-7" | 16'-7" |
| | PRI-50 | 23'-1" | 21'-1" | 19'-11" | 16'-1" |
| | PRI-60 | 24'-2" | 22'-1" | 20'-10" | 19'-5" |
| | PRI-70 | 25'-0" | 22'-10" | 21'-6" | 18'-6" |
| | PRI-80 | 26'-8" | 24'-3" | 22'-11" | 21'-3" |
| | PRI-90 | 27'-6" | 25'-0" | 23'-6" | 21'-10" |
| 14" | PRI-40 | 25'-11" | 22'-5" | 20'-5" | 18'-3" |
| | PRI-50 | 26'-3" | 23'-11" | 20'-2" | 16'-1" |
| | PRI-60 | 27'-6" | 25'-1" | 23'-8" | 19'-9" |
| | PRI-70 | 28'-5" | 25'-11" | 23'-2" | 18'-6" |
| | PRI-80 | 30'-3" | 27'-7" | 25'-11" | 23'-11" |
| | PRI-90 | 31'-2" | 28'-4" | 26'-8" | 24'-10" |
| 16" | PRI-40 | 27'-11" | 24'-2" | 22'-0" | 19'-8" |
| | PRI-50 | 29'-0" | 24'-3" | 20'-2" | 16'-1" |
| | PRI-60 | 30'-5" | 27'-9" | 24'-9" | 19'-9" |
| | PRI-70 | 31'-5" | 27'-10" | 23'-2" | 18'-6" |
| | PRI-80 | 33'-6" | 30'-6" | 28'-9" | 23'-11" |
| | PRI-90 | 34'-5" | 31'-4" | 29'-6" | 26'-7" |

- a. Allowable clear span applicable to multiple-span residential floor construction with a design dead load of 10 psf and live load of 40 psf. The end spans shall be 40% or more of the adjacent span. The live load deflection is limited to span/480.
- b. Spans are based on a composite floor with glued-nailed sheathing meeting the requirements for APA Rated Sheathing or APA Rated STURD-I-FLOOR conforming to PS 1, PS 2, CSA O325 or CSA O437 with a minimum 19/32 Performance Category (40/20 or 20 oc) for a joist spacing of 19.2 inches or less, or 23/32 Performance Category (48/24 or 24 oc) for a joist spacing of 24 inches. Adhesive shall meet ASTM D3498 or APA Specification AFG-01. Spans shall be reduced 12 inches when the floor sheathing is nailed only.
- c. Minimum bearing length shall be 1-3/4 inches for the end bearings and 3-1/2 inches for the intermediate bearings.
- d. Bearing stiffeners are not required when I-joists are used with the spans and spacings given in this table, except as required by hanger manufacturers.
- e. This span chart is based on uniform loads. For applications with other than uniformly distributed loads, an engineering analysis may be required based on the use of the design properties in Table 8 of *APA Performance Rated I-Joists, Form Z725*.

When handling I-joists with a crane on the job site (“picking”), take a few simple precautions to prevent damage to the joists and injury to the work crew: pick I-joists in bundles as shipped by the supplier, orient the bundles so that the webs of the I-joists are vertical and pick the bundles using a spreader bar if necessary. Do not twist or apply loads to the I-joists when they are horizontal. Never use or try to repair a damaged I-joist.

I-joists are not stable until completely installed and will not carry any load until fully braced and sheathed. Do not allow workers to walk on joists until the joists are fully installed and braced. To avoid accidents, brace and nail each I-joist as it is installed, using hangers, blocking panels, Rim Board® and/or cross-bridging at joist ends and over each support. For additional storage and handling recommendations, refer to *APA Builder Tips: APA Performance Rated I-Joist Storage, Handling, and Safety Recommendations*, Form Z735. An example of I-joist trademark is shown below.



APA Performance Rated I-Joist Specification Guide

The following is a guide for specifying APA Performance Rated I-Joists (PRI) to be used in residential floor applications. These structural products are available in net depths of 9-1/2, 11-7/8, 14 and 16 inches and can be used for simple- or multiple-span floor construction. Exterior use, or use of wood I-joists in other than dry conditions, is not recommended.

A. General

1. APA PRIs shall be furnished and installed as shown by the approved building plans and installation instructions.
2. The designation of APA PRIs shall be based on the applicable loading, joist spacing and spans shown in the plans. PRIs may be selected using Tables 11 and 12. For non-uniform loading conditions requiring an engineering analysis, see Table 8 of *APA Performance Rated I-Joists*, Form Z725, for PRI joist design properties.

The specification for I-joists required for a specific floor application shall include joist depth, designation, length and number of pieces required.

Example: 21 pieces—APA 9-1/2" PRI-40 x 30 feet long

3. All accessory products such as I-joist blocking panels, rim boards, squash blocks, web stiffeners, etc., shall be provided and installed in accordance with the applicable installation details shown in *APA Performance Rated I-Joists*, Form Z725.
4. APA trademarked structural glued laminated timber (glulam) or approved structural composite lumber (SCL) shall be furnished for load-bearing joist headers. The depth of these components shall be specified to match the I-joist depth when flush framing is required.

The contractor shall use approved connection hardware (joist hangers) as specified in the plans. Such hardware shall be compatible with the width and depth of APA PRIs furnished, to provide flush nailing surfaces at adjoining members and to prevent rotation.

B. Manufacture

1. **Materials, Manufacture and Quality Assurance**—Product quality shall conform to the manufacturer’s approved quality manual, with quality assurance inspection services provided by APA in accordance with building code requirements and the applicable APA Product Report or code evaluation report.
2. **Trademarks**—I-joists shall be marked with the APA trademark indicating conformance with the manufacturing, quality assurance and marking provisions of APA PRI-400, *Performance Standard for APA I-Joists*, Form X720, or the applicable manufacturer’s APA Product Report or code evaluation report.
3. **Job Site Shipment**—I-joists shall be protected from direct exposure to weather prior to installation.



APA PERFORMANCE RATED RIM BOARD® SELECTION AND SPECIFICATION

A Rim Board is the wood component that fills the space between the sill plate and bottom plate of a wall or, in second floor construction, between the top plate and bottom plate of two wall sections. The Rim Board must match the depth of the framing members between floors or between the floor and foundation to function properly. In addition to supporting the wall loads, the Rim Board ties the floor joists together. It is an integral component in an engineered wood system because it transfers both vertical bearing and lateral forces.

While lumber has been the traditional product used for Rim Boards, it is generally not compatible with the depth of the new generation of wood I-joists used in floor construction. With the increasing use of wood I-joists, a demand for compatible engineered wood Rim Boards has resulted.

APA Performance Rated Rim Boards can be manufactured using plywood, oriented strand board (OSB), glulam or structural composite lumber (SCL). These engineered wood Rim Boards have less shrinkage than lumber and match the depth of wood I-joists and other engineered wood framing products. They are available in lengths up to 24 feet, depending on the product used.

APA Performance Rated Rim Boards are manufactured in accordance with Voluntary Product Standards PS 1, PS 2 or ANSI A190.1 and meet the requirements of ANSI/APA PRR 410 *Standard for Performance-Rated Engineered Wood Rim Boards* or APA PRR-401 *Performance Standard for APA EWS Rim Boards*. ANSI/APA PRR 410 and APA PRR-401 meet or exceed the requirements given in the ICC-ES *Acceptance Criteria for Wood-Based Rim Board Products*, AC124. Engineered wood Rim Boards are defined in the International Building Code and International Residential Code. To meet this code definition, the engineered wood Rim Board shall conform to ANSI/APA PRR 410 or ASTM D7672, *Standard Specification for Evaluating Structural Capacities of Rim Board Products and Assemblies*.

As glued engineered wood products, APA Rim Boards have greater dimensional stability, higher strength, increased structural reliability, more consistent quality and a lower tendency to check or split than sawn lumber.

Note: Rim Board® is a registered trademark of APA – *The Engineered Wood Association*.

TYPICAL RIM BOARD TRADEMARKS

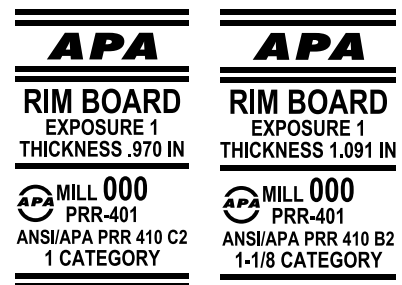

APA Performance Rated Rim Board® Specification Guide

The following is a guide for specifying APA Performance Rated Rim Boards for residential floor applications. These structural products are manufactured using plywood, oriented strand board (OSB), glued laminated timber (glulam) or structural composite lumber (SCL).

A. General

1. APA Performance Rated Rim Boards shall be furnished and installed as shown in the approved building plans and installation instructions.
2. The designation of APA Performance Rated Rim Boards shall be based upon joist depth and applicable loading and may be selected using Table 3 of *APA Performance Rated Rim Boards*, Form W345. For Rim Boards spanning openings, use Table 5 of Form W345. If other loads outside the scope of Table 5 are to be considered, see Table 4 of Form W345 for allowable edgewise bending properties.
3. The contractor shall use connection fasteners as detailed in *APA Performance Rated Rim Boards*, Form W345. Pay special attention to the nail spacing of the connection between the floor sheathing and the APA Performance Rated Rim Board to prevent splitting and decreased connection capacity.

B. Manufacture

1. **Materials, Manufacture and Quality Assurance**—Product quality shall conform to the manufacturer's approved quality manual, with quality assurance inspection services provided by APA in accordance with building code requirements.
2. **Trademarks**—Rim Boards shall be marked with the APA trademark indicating conformance with the manufacturing, quality assurance and marking provisions of *ANSI/APA PRR 410 Standard for Performance-Rated Engineered Wood Rim Boards* or *APA PRR-401 Performance Standard for APA EWS Rim Boards*.
3. **Job Site Shipment**—Rim Boards shall be protected from direct exposure to weather prior to installation.

CONSTRUCTION WITH ENGINEERED WOOD PRODUCTS

Building with engineered wood offers dependable performance and design flexibility over a wide range of construction applications. Engineered wood offers low in-place cost, versatility and resilience for floors, walls and roofs, and is ideally suited for other design needs like wind and fire resistance, noise control, energy efficiency, concrete forming and more.





FLOOR CONSTRUCTION

Engineered wood floor systems give builders and designers strength, dependable performance and design flexibility. A variety of floor framing and wood structural panel products can be used in floor construction. To select the appropriate products and floor design, it is essential to define the predicted loads and to consider both the structural requirements and compatibility with the finish floor requirements. Table 13 shows the most common finish floor products and the floor systems that are typically recommended for each.

TABLE 13

TYPICAL PANEL FLOOR SPECIFICATIONS BASED ON FINISH FLOOR INSTALLATIONS (All must meet minimum structural requirements^a of IBC or IRC)

| Finish Floor | Typical Panel Installation ^b | Example Specification ^b |
|--|--|---|
| Carpet and Pad | Single layer of APA Rated Sturd-I-Floor with T&G edges | APA Sturd-I-Floor 24 oc Exposure 1 T&G (for joists spaced 24 inches o.c. or less) |
| Hardwood Flooring | Single layer of APA Rated Sturd-I-Floor or APA Rated Sheathing | APA Rated Sturd-I-Floor 32 oc Exposure 1 (for joists spaced 24 inches o.c. or less) ^c |
| Lightweight Concrete with Finish Flooring on Top ^d | Subfloor panel with or without T&G edges installed on joists. Asphalt paper covers subfloor. Lightweight concrete poured on top. | APA Sturd-I-Floor 24 oc Exposure 1 T&G or APA Rated Sheathing 48/24 Exposure 1 (for joists spaced 24 inches o.c. or less) |
| Vinyl (or other thin resilient floor covering) or Glue-down Carpet | APA Rated Sturd-I-Floor or APA Rated Sheathing Exposure 1 plus minimum Performance Category 1/4 APA Underlayment ^e Sanded Face Exposure 1 | APA Rated Sturd-I-Floor ^f 24 oc Exposure 1 or APA Rated Sheathing 48/24 Exposure 1 (for joists spaced 24 inches o.c. or less). Cover with 1/4-inch (or thicker) APA Underlayment ^e Sanded Face Exposure 1 |
| Ceramic Tile ^h | Two layers minimum Performance Category 19/32 APA Rated Sturd-I-Floor ^c Exposure 1 | Two layers of minimum Performance Category 19/32 plywood APA Rated Sturd-I-Floor ^c 20 oc Exposure 1 (for joists spaced 16 inches o.c. or less) |

a. Floor span rating must equal or exceed joist spacing.

b. Refer to www.apawood.org for installation specifics and alternate installation combinations.

c. Minimum Performance Category 19/32 APA Sturd-I-Floor^f or APA Rated Sheathing for joist spaced 16 inches o.c. Minimum Performance Category 23/32 APA Sturd-I-Floor or APA Rated Sheathing for joist spaced 19.2 inches o.c. or less. See *APA Technical Note: APA Performance Rated Panel Subfloors Under Hardwood Flooring, Form R280*.

d. For gypsum concrete recommendations, contact manufacturer of floor topping.

e. APA Underlayment is always plywood.

f. Plywood APA Rated Sturd-I-Floor with sanded face. Plywood Rated Sturd-I-Floor is underlayment with a span rating.

g. For rough floors, specify minimum Performance Category 11/32 APA Underlayment^f.

h. For other specialty flooring products, including marble and slate, please refer to the finish floor manufacturer's recommendations. Enhanced structural performance may be required for ceramic and natural stone floor products. See *Tile Council of North America (TCNA) Handbook for Ceramic, Glass, and Stone Tile Installation* (www.tileusa.com).

APA Rated Sturd-I-Floor®

APA RATED STURD-I-FLOOR is a span-rated APA proprietary product designed specifically for use in single-layer floor construction beneath carpet and pad. The product provides all of the proven cost-saving and performance benefits of combined subfloor-underlayment construction. It is manufactured in conformance with Voluntary Product Standard PS 1 or PS 2. Plywood APA Sturd-I-Floor meets PS 1 underlayment specifications, but in addition to qualifying as underlayment, Sturd-I-Floor carries a span rating (thin underlayment carries no span rating). Sturd-I-Floor is easy to use and specify because the maximum recommended spacing of floor joists—or span rating—is stamped on each panel. Panels are manufactured with span ratings of 16, 20, 24, 32 and 48 inches. These assume use of the panel continuous over two or more spans with the long panel dimension or strength axis across supports.

Note: The span rating in the trademark applies when the long panel dimension or strength axis is across supports, unless the strength axis is otherwise identified.

Glue-nailing is recommended for STURD-I-FLOOR panels, though panels may be nailed only. Recommendations for both methods are given in Table 14. (See “The APA Glued Floor System,” page 47, for more detailed gluing recommendations.) Always protect smooth panel faces and tongue-and-groove edges from damage prior to and during application. Install with smooth side up. Recommended live loads are given in Table 15.

If long-term exposure to the weather is required, specify Exterior panels.

TABLE 14

APA RATED STURD-I-FLOOR^a

| Span Rating (Maximum Joist Spacing) (in.) | Panel Performance Category ^d | Fastening: Glue-Nailed ^b | | | Fastening: Nailed-Only | | |
|---|---|--------------------------------------|------------------------------------|------------------------------------|--------------------------------------|------------------------------------|----|
| | | Nail Size and Type ^e | Maximum Spacing (in.) ^c | | Nail Size and Type ^e | Maximum Spacing (in.) ^c | |
| | Supported Panel Edges ^f | | Intermediate Supports | Supported Panel Edges ^f | | Intermediate Supports | |
| 16 | 19/32, 5/8 | 6d ring- or screw-shank ^g | 6 ^h | 12 | 6d ring- or screw-shank | 6 | 12 |
| 20 ⁱ | 19/32, 5/8 | 6d ring- or screw-shank ^g | 6 ^h | 12 | 6d ring- or screw-shank | 6 | 12 |
| 24 | 23/32, 3/4 | 6d ring- or screw-shank ^g | 6 ^h | 12 | 6d ring- or screw-shank | 6 | 12 |
| | 7/8 | 8d ring- or screw-shank ^g | 6 | 12 | 8d ring- or screw-shank | 6 | 12 |
| 32 | 7/8 | 8d ring- or screw-shank ^g | 6 | 12 | 8d ring- or screw-shank | 6 | 12 |
| 48 | 1-3/32, 1-1/8 | 8d ring- or screw-shank ^g | 6 | k | 8d ring- or screw-shank ^g | 6 | k |

- a. Special conditions may impose heavy traffic and concentrated loads that require construction in excess of the minimums shown. See page 48 for heavy-duty floor recommendations.
- b. Use only adhesives conforming to ASTM D3498 or APA Specification AFG-01, applied in accordance with the adhesive manufacturer’s recommendations. If OSB panels with sealed surfaces and edges are to be used, use only solvent-based glues; check with panel manufacturer.
- c. Increased fastening schedules may be required where floor is engineered as a diaphragm.
- d. Panels in a given Performance Category may be manufactured in more than one span rating. Panels with a span rating greater than the actual joist spacing may be substituted for panels of the same Performance Category with a span rating matching the actual joist spacing. For example, Performance Category 19/32 Sturd-I-Floor 20 oc may be substituted for Performance Category 19/32 Sturd-I-Floor 16 oc over joists at 16 inches on center.
- e. See Table 6, page 17, for nail dimensions.
- f. Supported panel joints shall occur approximately along the centerline of framing with a minimum bearing of 1/2 inch. Fasten panels 3/8 inch from panel edges.
- g. 8d common nails may be substituted if ring- or screw-shank nails are not available.
- h. Check with local building official; some local jurisdictions permit nail spacing at 12 inches o.c.
- i. While span rating is shown as 20 oc, the actual joist spacing is 19.2 inches.
- j. 10d common nails may be substituted with Performance Category 1-1/8 panels if supports are well seasoned.
- k. Space nails maximum 6 inches for 48-inch spans and 12 inches for 32-inch spans.

Although STURD-I-FLOOR is suitable for direct application of carpet and pad, an additional thin layer of underlayment is recommended under tile, sheet flooring or fully adhered carpet. This added layer restores a smooth surface over panels that may have been scuffed or roughened during construction or that may not have received a sufficiently sanded surface. When plywood STURD-I-FLOOR with “sanded face” is specified, the surface is also suitable for direct application of resilient floor covering. If a “sanded face” panel is to be used, however, care must be taken during construction to prevent damage or roughening of the sanded face. Tongue-and-groove edges are recommended to be glued under thin floor coverings to assure snug joints.

If the floor has become wet during construction, it should be allowed to dry before application of finish floor, including carpet, underlayment, hardwood flooring and ceramic tile. After it is dry, the floor should be checked for flatness, especially at joints.

When floor members are dry, make sure fasteners are flush with or slightly below surface of the STURD-I-FLOOR panels just prior to installation of thin floor coverings. Fasteners should be set if green framing will present nail popping problems upon drying. Do not fill nail holes. To minimize the chance of floor squeaks, installers should press panels tightly onto joists by standing on the panel over the joist next to the nailing point. Fill and thoroughly sand edge joints (this step may not be necessary under some carpet and structural flooring products—check recommendations of flooring manufacturer). Fill any other damaged or open areas, such as splits, and sand all surface roughness. Ensure fill compound is fully cured before sanding because it may continue to expand as it cures.

FIGURE 1

APA RATED STURD-I-FLOOR 16, 20, AND 24 oc

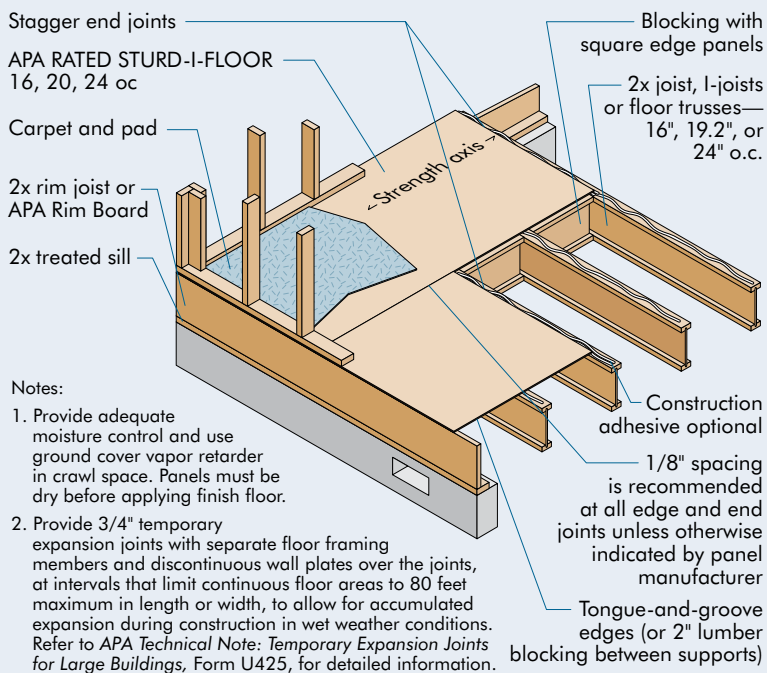

TYPICAL FLOOR SHEATHING TRADEMARKS

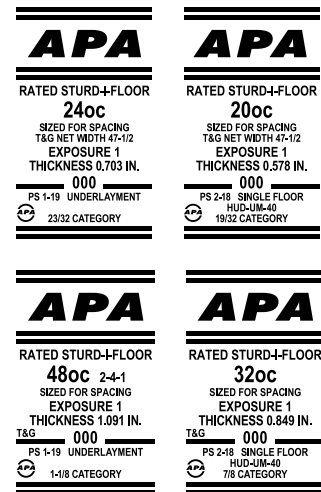

Sturd-I-Floor 32 oc and 48 oc

Install APA RATED STURD-I-FLOOR 48 oc or 32 oc panels over 2x joists or I-joists spaced 32 inches on center (Figure 2). Install APA RATED STURD-I-FLOOR 48 oc over 4x girders 48 inches on center (Figure 3). For the 48 on center method, supports may be 2x joists spiked together, 4x lumber, glued laminated timber (glulams), lightweight steel beams or wood I-joists or floor trusses. Girders of doubled 2x members should have top edges flush to permit smooth panel end joints.

For a low profile with supports 48 inches on center, beams can be set in foundation pockets or on posts supported by footings so that panels bear directly on the sill. If 4x lumber girders are used, they should be air dried and/or set higher than the sill to allow for shrinkage.

In some applications, particularly in hallways and other heavy traffic areas, greater stiffness in the floor may be desirable. Modifications to the 48-inch framing system, such as addition of straight or diagonal blocking, will increase stiffness considerably.

The APA Glued Floor System

The APA Glued Floor System is based on thoroughly tested gluing techniques and field-applied construction adhesives that firmly and permanently secure a layer of wood structural panels to wood joists.

The glue bond is so strong that floor and joists behave like integral T-beam units. Floor stiffness is increased appreciably over conventional construction, particularly when tongue-and-groove joints are glued. Gluing also helps eliminate squeaks, floor vibration, bounce and nail-popping.

FIGURE 2

APA RATED STURD-I-FLOOR 32 oc AND 48 oc (Over Supports 32" o.c.)

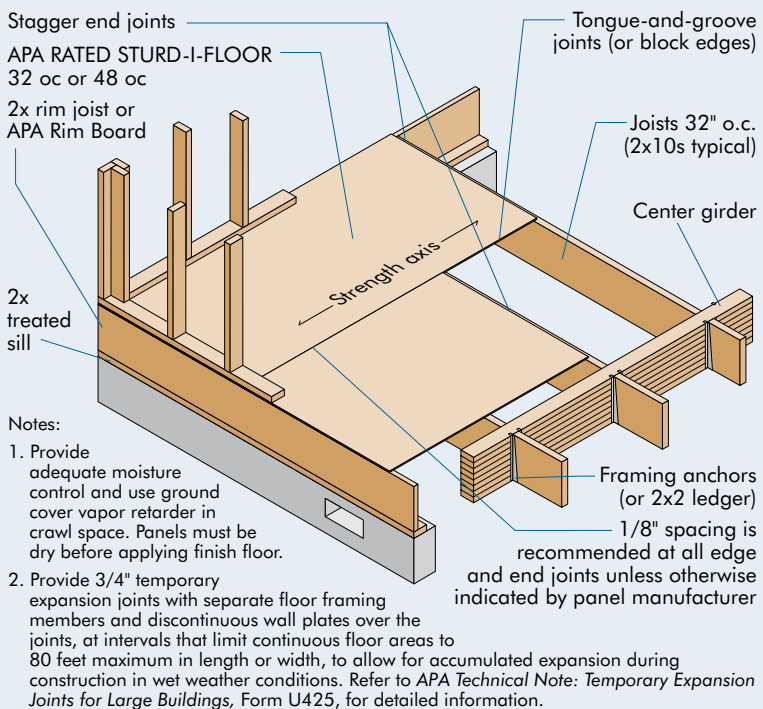
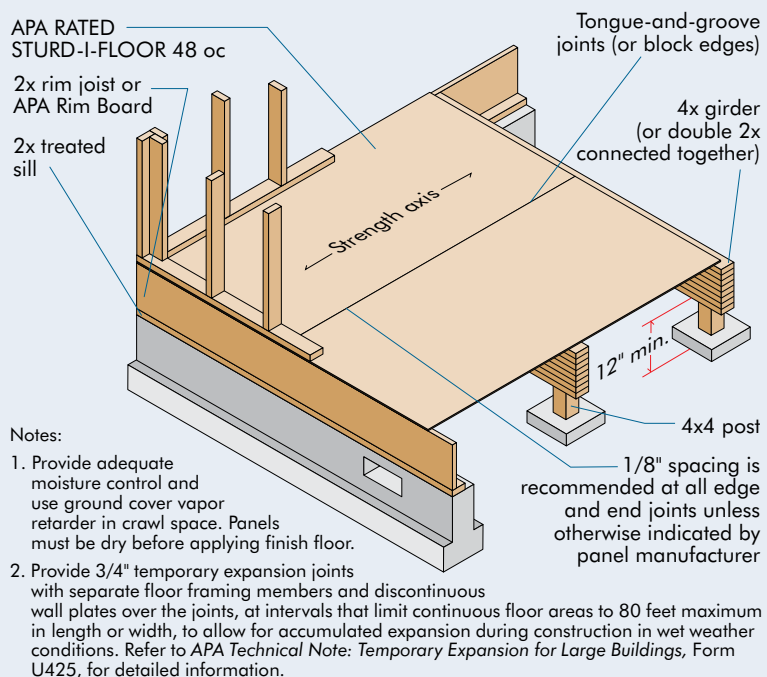

FIGURE 3

APA RATED STURD-I-FLOOR 48 oc (Over Supports 48" o.c.)



Field-glued floors go down quickly, even in cold weather, using ordinary construction materials and techniques. And like many other panel assemblies that provide excellent sound control, the APA Glued Floor System is ideal for multifamily construction. The large panels with glued tongue-and-groove joints reduce the number of cracks that can “leak” airborne noise.

The system is normally built with Span Rated STURD-I-FLOOR panels (Figure 4), although double-layer floors are also applicable. In both cases, STURD-I-FLOOR and subflooring panels should be installed continuous over two or more spans with the long dimension or strength axis across supports.

Panels recommended for glued floor construction are tongue-and-groove APA RATED STURD-I-FLOOR for single-floor construction and APA RATED SHEATHING for the subfloor when used with a separate underlayment layer or with structural finish flooring. An additional layer of underlayment should be applied in areas to be finished with resilient floor coverings, such as tile, linoleum, vinyl or fully adhered carpet. If plywood STURD-I-FLOOR with “sanded face” is specified, the surface is suitable for direct application of resilient floor covering and an additional layer is not required. If a “sanded face panel” is to be used, however, care must be taken during construction to prevent damage or roughening of the sanded face. Exposure 1 or Exterior panels have suitable bond performance for applications subject to moisture during or after construction, as in bathrooms and utility rooms.

Tongue-and-groove panels are highly recommended for single-floor construction. Before each panel is placed, a line of glue is applied to the joists with a caulking gun. The panel tongue-and-groove joint should also be glued, although less heavily, to avoid squeeze-out. If square-edge panels are used, edges must be supported between joists with 2x4 blocking. Glue panels to blocking to minimize squeaks. Blocking is not required under structural finish flooring, such as wood strip flooring, or if a separate underlayment layer is installed.

Only adhesives conforming with ASTM D3498 or Performance Specification AFG-01 developed by APA are recommended for use with the glued floor system. A number of brands meeting this specification are available from building supply dealers. If OSB panels with sealed surfaces and edges are to be used, use only solvent-based glues; check with panel manufacturer. Always follow the specific application recommendations of the glue manufacturer.

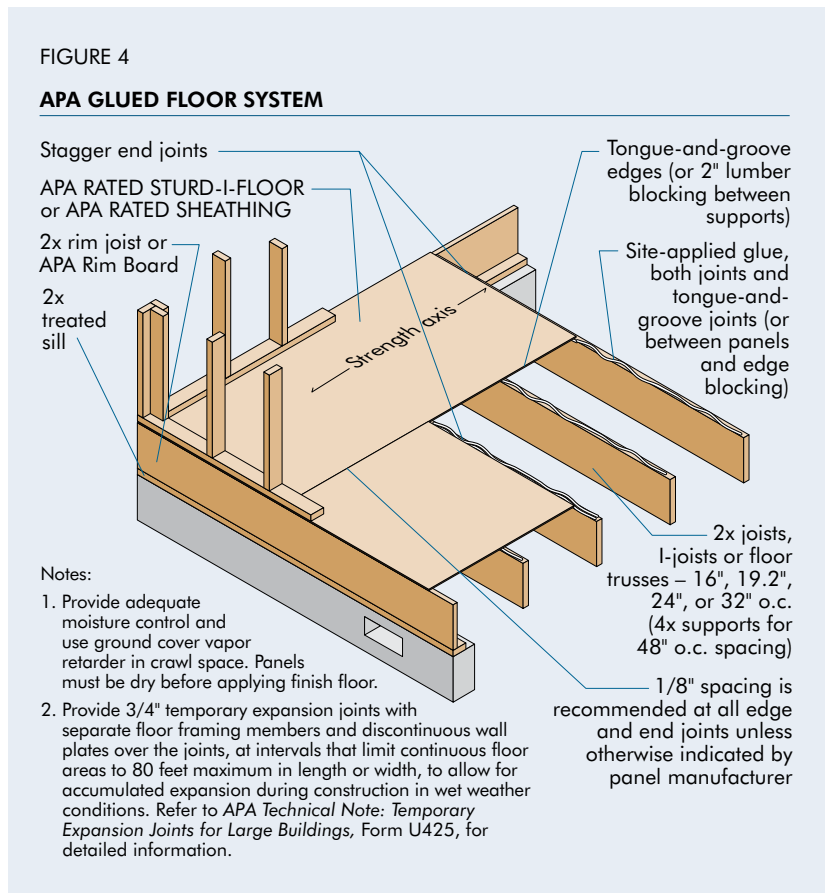

TYPICAL FLOOR SHEATHING TRADEMARKS

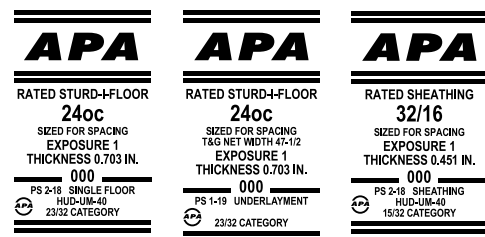

Application

For best results, follow these application procedures:

1. Snap a chalk line across joists 4 feet in from wall for panel edge alignment and as a boundary for spreading glue.
2. Spread only enough glue to lay one or two panels at a time or follow specific recommendations of glue manufacturer. Wipe any mud, dirt or water from joists before gluing.
3. Lay first panel with tongue side to wall and nail in place. This protects the tongue of next panel from damage when tapped into place with block and sledgehammer.
4. Apply a continuous line of glue (about 1/4-inch diameter) to framing members. Apply glue in a serpentine pattern on wide areas.
5. Apply two lines of glue on joists where panel ends butt to assure proper gluing of each end.
6. After first row of panels is in place, spread glue in groove of one or two panels at a time before laying next row. Glue line may be continuous or spaced, but avoid squeeze-out by applying a thinner line (1/8 inch) than on joists.
7. Tap second-row panels into place, using a block to protect groove edges.
8. Stagger end joints in each succeeding row, where possible. A 1/8-inch space between all end joints and edges, including tongue-and-groove, is recommended. Use a spacer tool to assure accurate and consistent spacing.
9. Complete all nailing of each panel before glue sets. (See Table 14.) Check the glue manufacturer's recommendations for allowable time. Warm weather accelerates glue setting. Use 6d ring- or screw-shank nails for panels with a Performance Category of 3/4 or smaller and 8d ring- or screw-shank nails for thicker panels. See Table 6 for nail dimensions. Space nails per Table 14. Closer nail spacing may be required for diaphragm construction. Finished deck can be walked on and will carry construction loads without damage to glue bond.

TABLE 15

RECOMMENDED UNIFORM FLOOR LIVE LOADS FOR APA RATED STURD-I-FLOOR AND APA RATED SHEATHING WITH STRENGTH AXIS PERPENDICULAR TO SUPPORTS^a

| Sturd-I-Floor Span Rating | Sheathing Span Rating | Minimum Panel Performance Category | Maximum Span (in.) | Allowable Live Loads (psf) ^b | | | | | | |
|---------------------------------|-----------------------------|--|--------------------------|---|-----|------|-----|-----|-----|-----------------|
| | | | | Joist Spacing (in.) | | | | | | |
| | | | | 12 | 16 | 19.2 | 24 | 32 | 40 | 48 ^c |
| 16 oc | 24/16, 32/16 | 7/16 ^d | 16 | 185 | 100 | | | | | |
| 20 oc ^e | 40/20 | 19/32 | 19.2 | 270 | 150 | 100 | | | | |
| 24 oc | 48/24 | 23/32 | 24 | 430 | 240 | 160 | 100 | | | |
| 32 oc | NA | 7/8 | 32 | | 405 | 295 | 185 | 100 | | |
| 48 oc | NA | 1-3/32 | 48 | | | 425 | 290 | 160 | 100 | 55 |

a. Panels 24" or wider applied over two spans or more, dry; normal load duration assumed.

b. 10 psf dead load assumed. Live load deflection limit is $l/360$.

c. 4x nominal or double 2x framing.

d. 19/32 is minimum Performance Category of Rated Sturd-I-Floor.

e. While span rating is shown as 20 oc, the actual joist spacing is 19.2 inches.

APA Panel Subflooring

The span ratings in Table 16 apply to APA RATED SHEATHING grades only and are the minimum recommended for the spans indicated. The spans assume panels continuous over two or more spans with the long dimension or strength axis across supports. The span rating in the trademark applies when the long panel dimension or strength axis is across supports unless the strength axis is otherwise identified.

TABLE 16

APA PANEL SUBFLOORING (APA RATED SHEATHING)^{a,b}

| Panel Span Rating | Panel Performance Category | Maximum Span (in.) | Nail Size & Type ^{c,d} | Maximum Nail Spacing (in.) | |
|-------------------|----------------------------|--------------------|---------------------------------|------------------------------------|-----------------------|
| | | | | Supported Panel Edges ^e | Intermediate Supports |
| 24/16 | 7/16 | 16 | 6d common | 6 | 12 |
| 32/16 | 15/32, 1/2 | 16 | 6d common ^f | 6 | 12 |
| 40/20 | 19/32, 5/8 | 19.2 ^f | 8d common | 6 | 12 |
| 48/24 | 23/32, 3/4 | 24 | 8d common | 6 | 12 |

- a. For subfloor recommendations under ceramic tile, refer to Table 18. For subfloor recommendations under gypsum concrete, contact manufacturer of floor topping.
- b. APA RATED STURD-I-FLOOR may be substituted when the span rating is equal to or greater than tabulated maximum span.
- c. Other code-approved fasteners may be used.
- d. See Table 6, page 17, for nail dimensions.
- e. Supported panel joints shall occur approximately along the centerline of framing with a minimum bearing of 1/2 inch. Fasteners shall be located 3/8 inch from panel edges.
- f. Span may be 24 inches if a minimum 1-1/2 inches of lightweight concrete is applied over panels.

FIGURE 5

APA PANEL SUBFLOORING

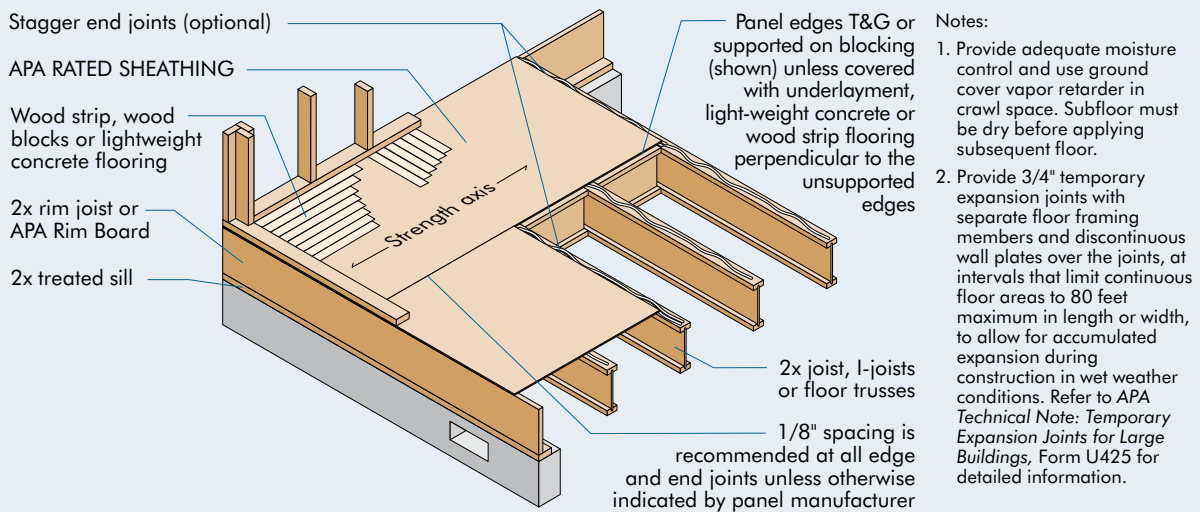

Recommended live loads are given in Table 15. Spans are limited to the values shown because of the possible effect of concentrated loads. Nailing recommendations are given in Table 16. Other code-approved fasteners may be used. APA panel subflooring may also be glued for added stiffness and to reduce squeaks using nailing recommendations in Table 14.

Long edges should be tongue-and-groove or supported with blocking unless:

1. A separate underlayment layer is installed with its joints offset from those in the subfloor. The minimum Performance Category of underlayment should be 1/4 for subfloors on spans up to 24 inches and 11/32 or larger panels on spans greater than 24 inches.
2. A minimum of 1-1/2 inches of lightweight concrete is applied over the panels.
3. 3/4-inch wood strip flooring is installed over the subfloor perpendicular to the unsupported edge.

If the floor becomes wet during construction, it should be allowed to dry before application of finish floor, including underlayment, hardwood flooring, ceramic tile and other flooring. After it is dry, the floor should be checked for flatness, especially at joints.

APA RATED SHEATHING Exposure 1 may be used where temporary exposure to moisture or weather is expected during construction. However, only Exterior panels should be used where long-term exposure to moisture or weather will be required.

In some nonresidential buildings, greater traffic and heavier concentrated loads may require construction in excess of the minimums given. Where joists are 16 inches on center, for example, panels with a span rating of 40/20 or 48/24 will give additional stiffness and strength. For beams or joists 24 or 32 inches on center, 1-1/8 Performance Category panels (APA RATED STURD-I-FLOOR 48 oc) will provide additional stiffness and strength.

APA Panel Floor Diaphragm

Floor framing members sheathed with wood structural panels behave as diaphragms. Diaphragms are typically a flat structural unit acting like a deep, thin beam. Floor diaphragms transfer lateral forces generated from wind, seismic and soil loads. Many floor diaphragms are not designed; they are built following the prescriptive provisions of the building code. In some cases, diaphragms must be designed to resolve significant lateral loads. For designed cases, refer to Table 40 and “APA Panel Roof Diaphragms” on page 84.

For more information about diaphragm design, see *APA Design/Construction Guide: Diaphragms and Shear Walls*, Form L350.

Lightweight Concrete Over APA Panels

APA Rated Sheathing or Sturd-I-Floor panels are an excellent base for lightweight concrete floors. See “APA Rated Sturd-I-Floor,” page 45, or “APA Panel Subflooring,” page 50, for application recommendations. For gypsum concrete recommendations, contact manufacturer of floor topping. Install panels continuous over two or more spans with the strength axis across supports. Use a moisture barrier when recommended by concrete manufacturer. See “Noise Transmission Control” and Figure 39 on page 96 for an illustration of a typical assembly.

APA Plywood Underlayment

APA Underlayment is a special grade of plywood that has enhanced resistance to face-veneer punctures. This is accomplished by imposing special limitations on the face veneer thickness, species of the face veneer and voids beneath the face veneer. Other grades, such as A-C Exterior, are only suitable if they have the additional underlayment designation or “Plugged Crossbands Under Face” noted in the trademark. Plywood meeting the underlayment standard in PS 1 will have the word “Underlayment” in the trademark (see example on page 11). Plywood Sturd-I-Floor, however, also meets the enhanced puncture-resistance requirements for underlayment, in addition to being span rated. (See “APA Rated Sturd-I-Floor,” page 45.) Refer to *APA Data File: Selection, Installation and Preparation of Plywood Underlayment for Resilient Floor Covering*, Form L335, for installation recommendations.

Underlayment grades of plywood have a solid, touch-sanded surface for direct application of carpet and pad. For areas to be covered with resilient floor covering, specify panels with “sanded face,” or certain other grades as noted in Table 17. Special inner-ply construction of underlayment resists dents and punctures from concentrated loads. Applied as recommended, plywood underlayment is also dimensionally stable and eliminates excessive swelling and subsequent buckling or humps around nails.

Always protect plywood underlayment against physical damage or water prior to application. Panels should, however, be allowed to equalize to atmospheric conditions by standing individual panels on edge for several days before installation.

Install plywood underlayment, smooth side up, immediately before laying the finish floor. For maximum stiffness, place face grain across supports. Edge joints of underlayment panels should be offset by at least 2 inches from joints of subfloor panels. Underlayment end joints should be offset from subfloor end joints by at least one joist spacing, and underlayment end joints should be offset from floor joists by 2 inches, so that nails miss the framing (to minimize the chance of nail pops).

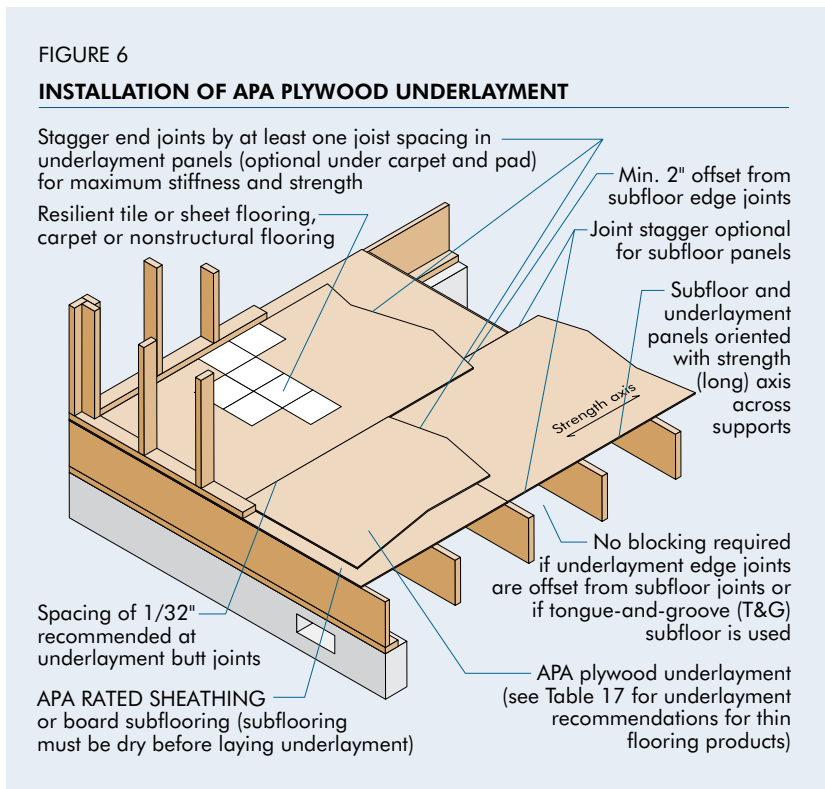

TABLE 17

APA PLYWOOD UNDERLAYMENT^a

| Plywood Grades ^b | Application | Minimum Plywood Performance Category | Fastener Size and Type ^c | Maximum Fastener Spacing (in.) ^d | |
|---|---|--------------------------------------|---|---|--------------|
| | | | | Panel Edges ^e | Intermediate |
| APA UNDERLAYMENT, APA C-C Plugged EXT, APA RATED STURD-I-FLOOR (19/32 or larger Performance Category) | Over smooth subfloor | 1/4 | 1-1/4" x 0.099" (minimum) ring- or screw-shank nails ^f | 3 | 6 each way |
| | Over lumber subfloor or uneven surfaces | 11/32 | | 6 | 8 each way |

- a. For underlayment recommendations under ceramic tile, refer to Table 18.
- b. In areas to be finished with resilient floor coverings such as tile or sheet vinyl, or with fully adhered carpet, specify Underlayment, C-C Plugged or veneer-faced STURD-I-FLOOR with “sanded face.” Underlayment A-C, Underlayment B-C, Marine EXT or sanded plywood grades marked “Plugged Crossbands Under Face,” “Plugged Crossbands (or Core),” “Plugged Inner Plies” or “Meets Underlayment Requirements” may also be used under resilient floor coverings.
- c. See Table 6, page 17, for nail dimensions.
- d. Fasteners for 5-ply plywood underlayment panels and for panels with a Performance Category greater than 1/2 may be spaced 6 inches on center at edges and 12 inches each way intermediate.
- e. Fasten panels 3/8" from panel edges.
- f. Use 1-1/2" x 0.099" (minimum) ring- or screw-shank nails for underlayment panels with a Performance Category of 19/32 to 3/4.

Begin fastening at one edge next to a preceding panel. Assuring that the panel is uniformly flat, continue by fully fastening toward opposite edge. If power-driven fasteners are used, foot pressure should be applied near the fastener to ensure firm contact between the underlayment and subfloor. Make sure fasteners are flush with, or just slightly below, surface of underlayment just prior to installation of resilient floor coverings such as tile, or sheet vinyl. See Table 17 for underlayment recommendations for thin flooring products. Fill and thoroughly sand edge joints. This step may not be necessary under some carpet and structural flooring products—check recommendations of flooring manufacturer. Fill any other damaged or open areas, such as splits, and sand all surface roughness. Ensure fill compound is fully cured before sanding because it may continue to expand as it cures.

The plywood underlayment needed to bridge an uneven floor will depend on roughness and loads applied. Although a minimum 11/32 Performance Category is recommended, 1/4 Performance Category plywood underlayment may also be acceptable over smooth subfloors, especially in remodeling work. See Table 17.

Where floors may be subject to temporary moisture, use panels with exterior glue (Exposure 1) or APA C-C PLUGGED Exterior. APA C-D PLUGGED is not an adequate substitute for underlayment grade since it does not have equivalent face veneer puncture resistance.

Hardwood Flooring Over APA Panel Subfloors

APA panel subfloor spans for all wood flooring products including solid strip and plank, engineered wood and parquet flooring are limited to maximum spacing of floor framing listed in Table 16. For improved stiffness, spans reduced from the maximum are recommended by the National Wood Floor Association (NWFA)^a. NWFA also recommends the use of minimum 19/32 Performance Category wood structural panels as a subfloor material when joists are spaced at 16 inches on center. For wider spacing, thicker panels are recommended.

Because wood flooring is sensitive to moisture, it is critical that subflooring panels are dry before the flooring is installed. Use a moisture meter calibrated to the specific subflooring panels to measure the moisture content of the subfloor. Do not install wood flooring unless subfloor moisture level is within a range consistent with the wood flooring manufacturer's recommendations. Whether the home is built over a crawl space or basement, make sure that those spaces are dry. Unvented crawl spaces should be well-drained, properly insulated and adequately ventilated. Unvented crawl spaces should be well sealed and insulated around the perimeter and be conditioned using the house's mechanical heating and cooling system, where required by the International Residential Code. APA recommends that both vented and unvented crawl spaces have a properly installed 6-mil minimum polyethylene vapor retarder over the ground. The vapor retarder should also extend up the crawl space perimeter walls where required by the International Residential Code.

Follow the recommendations of the NWFA for the wood flooring product being used for its storage and handling and for acclimatizing the flooring prior to installation on the subflooring. Also see APA Technical Notes: *APA Performance Rated Panel Subfloors under Hardwood Flooring*, Form R280, and *Prevent Callbacks in Wood Flooring Installation*, Form T350.

TYPICAL UNDERLAYMENT TRADEMARKS

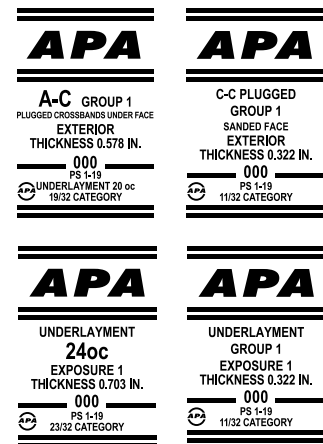

a. National Wood Flooring Association, 111 Chesterfield Industrial Boulevard, Chesterfield, Missouri 63005; Phone (800) 422-4556 (USA); (636) 519-9663 (local and international); www.nwfa.org.

Ceramic Tile Over APA Plywood Floors

Recommendations for several plywood floor systems suitable for application of ceramic tile are given in Table 18, based on specifications of the Tile Council of North America (TCNA)^a. In designing such a floor system, expected live loads, concentrated loads, impact loads and dead loads, including weight of the tile and setting bed, need to be considered. For additional details and assemblies, see *Technical Topic: Ceramic Tile Over Wood Structural Panel Floors*, Form TT-006, at www.apawood.org.

TABLE 18

APA FLOOR SYSTEMS FOR CERAMIC TILE FLOORING BASED ON THE TILE COUNCIL OF NORTH AMERICA HANDBOOK FOR CERAMIC, GLASS, AND STONE TILE INSTALLATION

| TCNA No. | Service Classification ^{a,b} | Max. Joist Spacing (in. o.c.) | Underlayment Layer | Subfloor Layer | Comment |
|----------|---------------------------------------|-------------------------------|--|--------------------------------------|---|
| F141 | Light Commercial | 16 | Mortar bed (1-1/4" minimum, 2" maximum) | 19/32" Exposure 1 T&G plywood | — |
| F142 | Residential | 16 | 19/32" Exposure 1 plywood | 19/32" Exposure 1 T&G plywood | — |
| F143 | Residential or Light Commercial | 16 | Light commercial – 19/32" Exposure 1 plywood | 19/32" Exposure 1 T&G plywood | 15/32" plywood underlayment layer gives "Residential" performance |
| F144 | Residential or Light Commercial | 16 | Cementitious backer units or fiber cement underlayment | 23/32" Exposure 1 T&G plywood | 19/32" plywood subfloor gives "Residential" performance |
| F145 | Light Commercial | 16 | 3/4" Minimum to 1-1/2" maximum mortar bed | 23/32" Exposure 1 T&G plywood | Cleavage membrane plus metal lath |
| F146 | Light Commercial | 16 | Coated glass-mat backer board | 19/32" Exposure 1 T&G plywood | — |
| F147 | Residential | 24 ^c | 3/8" Exposure 1 plywood plus uncoupling membrane | 23/32" Exposure 1 T&G plywood | 4" x 4" or larger tile only |
| F148 | Residential | 19.2 | Uncoupling membrane | 23/32" Exposure 1 T&G plywood | 3" x 3" or larger tile only |
| F149 | Residential | 24 | 19/32" Exposure 1 plywood | 23/32" Exposure 1 T&G plywood | 8" x 8" or larger tile only |
| F150 | Residential or Light Commercial | 16 | Light commercial – 19/32" Exposure 1 plywood | 19/32" Exposure 1 T&G plywood | 15/32" plywood underlayment layer gives "Residential" performance |
| F151 | Residential | 24 | Coated glass-mat backer board | 7/8" Exposure 1 T&G plywood | 8" x 8" or larger tile only |
| F152 | Residential | 24 ^c | 3/8" Exposure 1 plywood | 23/32" Exposure 1 T&G plywood | 4" x 4" or larger tile only |
| F155 | Residential | 24 | 19/32" Exposure 1 plywood | 23/32" Exposure 1 T&G OSB or plywood | OSB subfloor OK |
| F160 | Light Commercial | 24 | 3/8" plywood | 23/32" Exposure 1 T&G plywood | 8" x 8" or larger tile only |
| F170 | Light Commercial | 16 | Fiber-reinforced gypsum panel | 19/32" Exposure 1 T&G plywood | — |
| F175 | Light Commercial | 16 | Cementitious-coated foam backer board | 19/32" Exposure 1 T&G plywood | 8" x 8" or larger tile only |
| F180 | Light Commercial | 16 | Poured gypsum minimum 3/4" | 23/32" Exposure 1 T&G plywood | — |

Continued on next page

a. Tile Council of North America, Inc., 100 Clemson Research Blvd., Anderson, South Carolina 29625, phone (864) 646-8453, www.tcnatile.com.

TABLE 18 (Continued)

APA FLOOR SYSTEMS FOR CERAMIC TILE FLOORING BASED ON THE TILE COUNCIL OF NORTH AMERICA HANDBOOK FOR CERAMIC, GLASS, AND STONE TILE INSTALLATION

| TCNA No. | Service Classification ^{a,b} | Max. Joist Spacing (in. o.c.) | Underlayment Layer | Subfloor Layer | Comment |
|----------|---------------------------------------|-------------------------------|--|--|---|
| F185 | Residential | 19.2 | Cementitious self-leveling | 23/32" Exposure 1 T&G plywood | — |
| RH122 | Light Commercial | 16 | Poured gypsum minimum 3/4" | 23/32" Exposure 1 T&G plywood | — |
| RH123 | Light Commercial | 16 | Cementitious self-leveling minimum 1/2" | 23/32" Exposure 1 T&G plywood | — |
| RH130 | Residential or Light Commercial | 16 | Light Commercial – 19/32" Exposure 1 plywood | 19/32" Exposure 1 T&G plywood | 15/32" plywood Underlayment layer gives "Residential" performance |
| RH135 | Residential or Light Commercial | 16 | Various backer boards | Light commercial – 23/32" Exposure 1 T&G plywood | 19/32" plywood subfloor gives "Residential" performance |
| RH140 | Residential | 19.2 | Cementitious self-leveling | 23/32" Exposure 1 T&G plywood | — |
| RH141 | Light Commercial | 16 | Cleavage membrane reinforced 1-1/4" minimum to 2" maximum mortar bed | 19/32" Exposure 1 T&G plywood | — |

- a. Order of increasing serviceability: Residential, Light Commercial, Moderate and Heavy.
- b. As typically performed, the ASTM C627 Robinson-Type Floor Tester delivers three simultaneous, dynamic, 300-pound concentrated wheel loads moving in a 30-inch-diameter circle over the surface of test assembly. The number of cycles the system withstands without failure determines its Service Classification. One criterion used to determine failure is a maximum deflection of L/360 under the three concentrated loads.
- c. 1-1/2 inch net support width permitted with 8x8 inches or larger tile—otherwise 2-1/4 inches net support width is required.

APA Panel Stair Treads and Risers

Builders and manufacturers use APA panels for treads and risers of both site-fabricated and prefabricated stairs in closed-riser stairways. Risers support the front and back of the tread, creating a very short effective span.

APA panel stair treads may be used interchangeably with boards when the system is to include closed risers. Maximum span between stringers is 42 inches (check local code requirements). Rounded nosing may be machined into the tread but should be covered by a finish flooring material such as carpet and pad in order to prevent excessive wear or damage to veneers exposed by rounding. Risers may be any available APA panel grade with a Performance Category of at least 19/32. Panel grade and Performance Category recommendations for the treads are given in Table 19. Glue is recommended to improve stiffness of connections and to eliminate squeaks. Apply construction adhesive meeting ASTM D3498 or APA Performance Specification AFG-01 to all joints, with particular attention to the connection at the back riser. Regardless of where glue is used, nail all edges of treads as indicated in Figure 7. Detail A is the simplest system, but Detail B is preferred since it eliminates end-grain nailing at the back riser and may be used for all recommended panels.

Heavy Duty Plywood Floors

Above-grade plywood floors may be designed to support forklift trucks in areas of heavy loading or to support relatively high loads imposed by warehouse shelving or stacked storage. Heavy-duty plywood floors also make excellent mezzanine decks and vibration-resistant surfaces for mounting computer equipment. Tables 20 and 21 give plywood recommendations for uniform and concentrated (e.g., forklift traffic) loads. These assume the use of plywood continuous over two or more spans with face grain across supports. Structural edge support must be provided where high concentrated loads occur. Where no lift-truck use is expected, 2-inch wood framing is adequate. In addition to providing structural strength, a wearing surface should be provided to resist crushing wood cells and avoid abrasion whenever an industrial floor is subject to hard wheel or caster traffic. An expendable layer of plywood or a dense wear surface, such as tempered hardboard, should be used if wheels are small, hard or heavily loaded.

FIGURE 7

APA PANEL STAIR TREADS AND RISERS

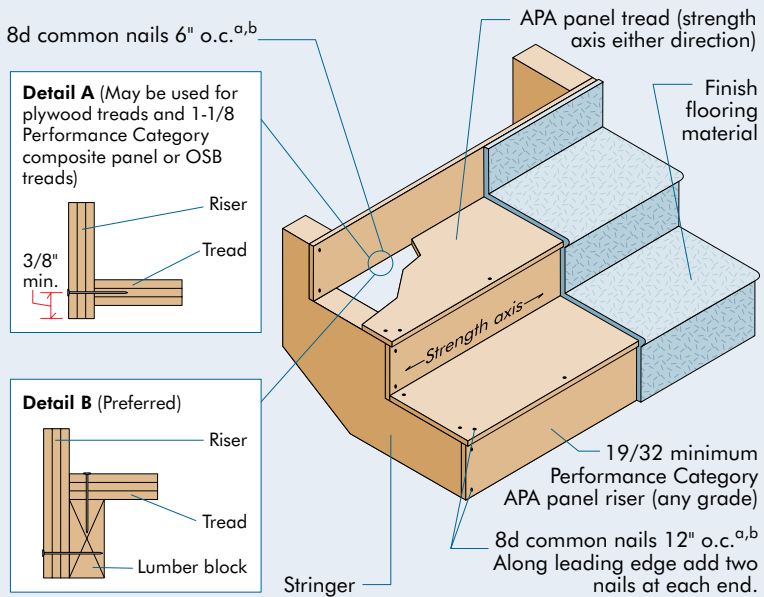

- a. Pre-drill tread end grain at mid-thickness with 3/32" bit. Maintain at least 3/8" edge distance in riser.
- b. See Table 6, page 17, for nail dimensions.

TABLE 19

APA PANEL STAIR TREADS

| Panel Grade ^a | Minimum Performance Category | |
|--------------------------|------------------------------|-------------|
| | Nail Glued | Nailed-Only |
| APA RATED STURD-I-FLOOR | 19/32 | 23/32 |

a. Other appropriate APA panel grades may be substituted for Sturd-I-Floor, providing minimum thickness complies with recommendations above.

TABLE 20

PS 1 PLYWOOD SPAN RATING OR PERFORMANCE CATEGORY RECOMMENDATIONS FOR UNIFORMLY LOADED HEAVY DUTY FLOORS^a (Deflection limited to 1/240 of span.)

| Uniform Live Load (psf) | Center-to-Center Support Spacing (in.) (Nominal 2-Inch-Wide Supports Unless Noted) | | | | | |
|-------------------------|--|-----------------|-------------------|---|---|-------------------------------------|
| | 12 ^b | 16 ^b | 19.2 ^b | 24 ^b | 32 | 48 ^c |
| 50 | 32/16, 16 oc | 32/16, 16 oc | 40/20, 20 oc | 48/24, 24 oc | 48 oc | 48 oc |
| 100 | 32/16, 16 oc | 32/16, 16 oc | 40/20, 20 oc | 48/24, 24 oc | 48 oc | 1-1/2 ^d |
| 125 | 32/16, 16 oc | 32/16, 16 oc | 40/20, 20 oc | 48/24, 24 oc | 48 oc | 1-3/4 ^d , 2 ^d |
| 150 | 32/16, 16 oc | 32/16, 16 oc | 40/20, 20 oc | 48/24, 48 oc | 48 oc | 1-3/4 ^e , 2 ^d |
| 200 | 32/16, 16 oc | 40/20, 20 oc | 48/24, 24 oc | 48 oc | 1-1/8 ^e , 1-3/8 ^d | 2 ^e , 2-1/2 ^d |
| 250 | 32/16, 16 oc | 40/20, 24 oc | 48/24, 48 oc | 48 oc | 1-3/8 ^e , 1-1/2 ^d | 2-1/4 ^e |
| 300 | 32/16, 16 oc | 48/24, 24 oc | 48 oc | 48 oc | 1-1/2 ^e , 1-5/8 ^d | 2-1/4 ^e |
| 350 | 40/20, 20 oc | 48/24, 48 oc | 48 oc | 1-1/8 ^e , 1-3/8 ^d | 1-1/2 ^e , 2 ^d | |
| 400 | 40/20, 20 oc | 48 oc | 48 oc | 1-1/4 ^e , 1-3/8 ^d | 1-5/8 ^e , 2 ^d | |
| 450 | 40/20, 24 oc | 48 oc | 48 oc | 1-3/8 ^e , 1-1/2 ^d | 2 ^e , 2-1/4 ^d | |
| 500 | 48/24, 24 oc | 48 oc | 48 oc | 1-1/2 ^d | 2 ^e , 2-1/4 ^d | |

- a. Use plywood with T&G edges, provide structural blocking at panel edges or install a separate underlayment.
- b. A-C Group 1 sanded plywood panels may be substituted for span rated Sturd-I-Floor panels (1/2 Performance Category for 16 oc; 5/8 Performance Category for 20 oc; 3/4 Performance Category for 24 oc).
- c. Nominal 4-inch-wide supports.
- d. Group 1 face and back, any species inner plies, sanded or unsanded, single layer. Numbers given are Performance Categories.
- e. All-Group 1 or Structural I plywood, sanded or unsanded, single layer. Numbers given are Performance Categories.

TABLE 21

PS 1 PLYWOOD SPAN RATING OR PERFORMANCE CATEGORY RECOMMENDATIONS FOR FLOORS CARRYING FORK-TRUCK TRAFFIC^{a,b,c} (Plywood grade is all-Group 1 or Structural I A-C or C-C Plugged, except where 1-1/8 STURD-I-FLOOR 48 oc is noted.)

| Tire Tread Print Width (in.) | Load per Wheel (lbs.) | Center-to-Center Support Spacing (in.) (Minimum 3-Inch-Wide Supports) | | | |
|------------------------------|-----------------------|---|-------|-------|-------|
| | | 12 | 16 | 19.2 | 24 |
| 3 | 500 | 48 oc | 48 oc | 48 oc | 48 oc |
| | 1000 | 1-1/4 | 1-1/4 | 1-1/4 | 1-1/4 |
| | 1500 | 1-1/2 | 1-3/4 | 1-3/4 | 1-3/4 |
| | 2000 | 2 | 2 | 2-1/4 | 2-1/4 |
| 5 | 1000 | 48 oc | 48 oc | 1-1/8 | 1-1/8 |
| | 1500 | 1-1/8 | 1-1/8 | 1-1/4 | 1-1/4 |
| | 2000 | 1-1/4 | 1-1/2 | 1-1/2 | 1-3/4 |
| | 2500 | 1-1/2 | 2 | 2 | 2 |
| | 3000 | 1-3/4 | 2 | 2-1/4 | 2-1/4 |
| 7 | 2000 | 1-1/8 | 1-1/8 | 1-1/4 | 1-1/4 |
| | 3000 | 1-1/4 | 1-1/2 | 1-1/2 | 1-3/4 |
| | 4000 | 1-3/4 | 1-3/4 | 1-3/4 | 2 |
| | 5000 | 2 | 2 | 2-1/4 | 2-1/2 |
| | 6000 | 2-1/4 | 2-1/2 | 2-3/4 | 3 |
| 9 | 3000 | 1-1/4 | 1-1/4 | 1-1/4 | 1-1/4 |
| | 4000 | 1-1/2 | 1-1/2 | 1-3/4 | 1-3/4 |
| | 5000 | 1-3/4 | 1-3/4 | 2 | 2 |
| | 6000 | 2 | 2 | 2-1/4 | 2-1/4 |
| | 7000 | 2-1/4 | 2-1/4 | 2-3/4 | 2-3/4 |

- a. Structural blocking (3x4 or 2x6 min.) required at all panel edges. Support blocking with framing anchors of adequate capacity or similar devices.
- b. Provide a wearing surface such as Plyon, polyethylene or a separate layer of plywood, hardboard or other hard surface when loads are due to casters, or small, hard wheels. A wearing surface should also be considered for areas where fork-truck traffic is stopping, starting or turning in a tight radius.
- c. Use ring- or screw-shank nails with length sufficient to penetrate framing 1-1/2 inches or panel thickness, whichever is greater. Space nails maximum 4 inches o.c. at panel edges and 8 inches o.c. at intermediate supports.



WALL CONSTRUCTION

Walls are a critical structural component in any structure. Building codes require that walls resist wind pressures and wall-racking forces and provide weather protection. Builders and designers can choose from a variety of wall sheathing products and wall systems. This section provides an overview of several commonly used systems and shows details on how wood structural panels can be used to meet fundamental requirements in wall applications.

Continuously Sheathed Wood Walls

Continuous wood structural panel sheathing contributes to a structure's ability to handle uplift loads, lateral loads and wind pressures while providing connections to the roof and protecting occupants. It is an easy, economical way to meet International Residential Code (IRC) bracing requirements while helping builders maximize energy efficiency. Continuous wood panel sheathing also serves as an excellent, code-compliant nail base for cladding attachment when the proper number and size of fasteners are used.

APA Panel Wall Sheathing

APA RATED SHEATHING meets building code requirements for wall bracing (Figures 8 and 9). Continuous wood structural panel wall bracing provides the greatest flexibility when bracing walls with window and door openings. It is most commonly used directly under siding, but can also be used in combination with continuous insulated sheathing.

Recommended wall sheathing spans with brick veneer or masonry are the same as those for panel sheathing (see Table 22). See Figure 10 for installation recommendations.

Panel recommendations for panelized wall sections are the same as for built-in-place walls.

Note: To minimize the potential for panel buckling, gluing of wall sheathing to framing is not recommended, except when recommended by the adhesive manufacturer for wall sheathing that already has been permanently protected by siding. Check with the local jurisdiction for the use of adhesive attachment of shear wall sheathing in high seismic zones.

TYPICAL SHEATHING TRADEMARKS

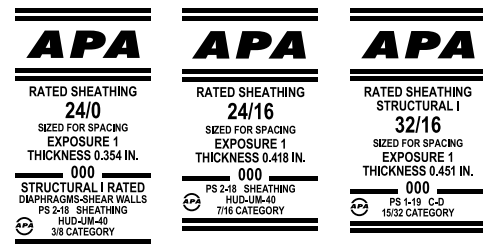

FIGURE 8

APA PANEL WALL SHEATHING

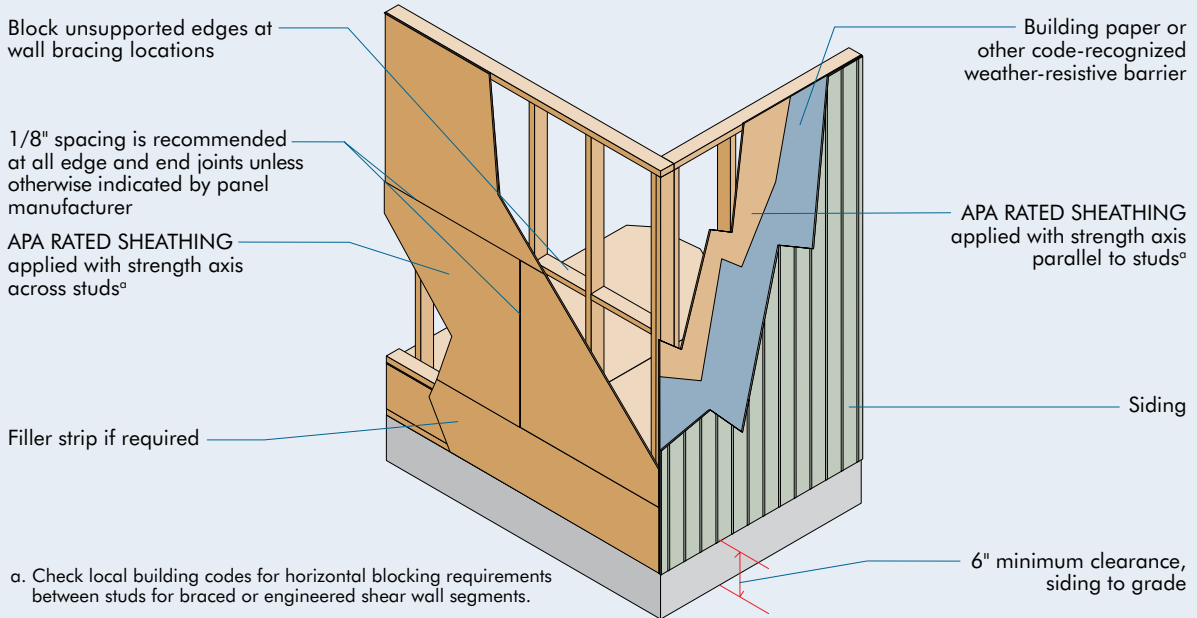

FIGURE 9

WALL BRACING

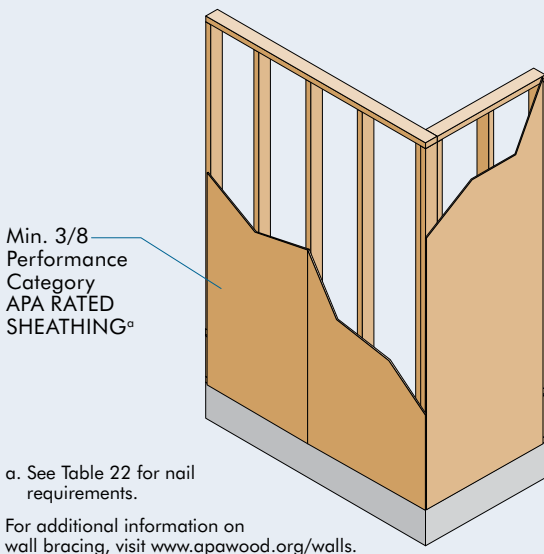

FIGURE 10

BRICK VENEER OVER APA PANEL SHEATHING

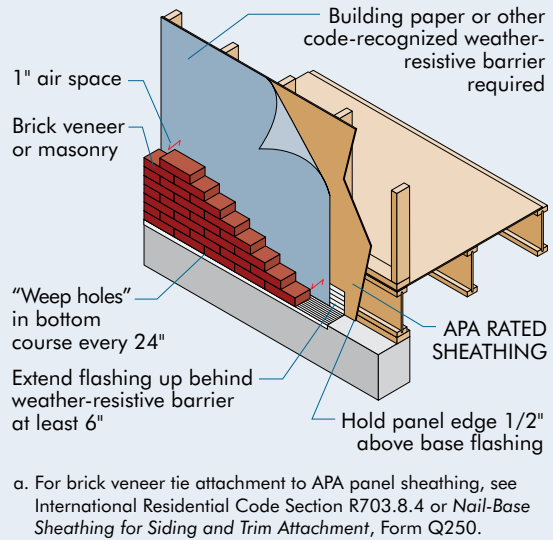

TABLE 22

APA RATED SHEATHING APPLIED DIRECT-TO-STUDS^{a,b,c}

| Minimum Nail ^d | | Minimum Wood Structural Panel Span Rating | Minimum Panel Performance Category | Wall Stud Spacing (in.) | Panel Nail Spacing | | Ultimate Design Wind Speed (mph) | | | |
|---------------------------|---------------------------|---|------------------------------------|-------------------------|--------------------|------------------|----------------------------------|------------|------------|---|
| Shank Diameter (in.) | Minimum Penetration (in.) | | | | Edges (in. o.c.) | Field (in. o.c.) | Wind Exposure Category | | | |
| | | | | | | | | B | C | D |
| 0.113 | 1.5 | 24/0 | 3/8 | 16 | 6 | 12 | 140 | 115 | 110 | |
| | | 24/16 | 7/16 | 16 | 6 | 12 6 | 140 190 | 130 160 | 115 140 | |
| 0.131 | 1.75 | 24/16 | 7/16 | 16 | 6 | 12 | 170 | 140 | 135 | |
| | | | | 24 or less | 6 | 12 | 140 | 115 | 110 | |

- a. Panel strength axis parallel or perpendicular to supports. Three-ply plywood sheathing with studs spaced more than 16 inches on center shall be applied with panel strength axis perpendicular to supports.
- b. Table is based on wind pressures acting toward and away from building surfaces, at 30-ft height in wall Zone 5 (corners) with smallest effective area, per Chapter 30 of ASCE 7-16 and Section R301.2 of the 2018 IRC, stud specific gravity = 0.42.
- c. Supported panel joints shall occur approximately along the center line of framing with a minimum bearing of 1/2 inch.
- d. See Table 6, page 17, for nail dimensions.
- e. See Table 24 for wall sheathing recommendations under exterior stucco finishes.

Wood Structural Panel Wall Bracing and Shear Walls

Wood structural panel wall bracing and shear walls are used to resist racking forces caused by lateral loads from wind or seismic events. While wall bracing and shear walls serve the same purpose, they have distinct differences, as explained below.

Wall Bracing

Wall bracing is typically a part of conventional prescriptive construction as found in 2018 International Building Code (IBC) Section 2308 or the International Residential Code (IRC) Section 6.10. Wall bracing is prescribed in a how-to format, and braced walls generally do not require hold-down devices or tight fastener schedules. Usually, there is no engineering required when using prescriptive wall bracing. For structures or portions of walls that do not meet the prescriptive construction parameters in the IBC or IRC, engineered design is required.

Meeting the bracing requirements is less complex when using wood structural panel wall sheathing because of its inherent strength. When a house design includes many openings, including large openings like garage doors, use of continuous wood structural panel wall sheathing provides increased design flexibility through the continuously sheathed bracing methods in the IRC. Such methods as continuously sheathed wood structural panel (CS-WSP) and continuously sheathed portal frame (CS-PF) permit wall bracing units shorter than typical 4-foot lengths (Figure 11), provided the entire wall line is continuously sheathed, including above and below openings. Continuously sheathed portal frames have become a common solution for bracing narrow walls located adjacent to garage openings because a wall length as short as 16 inches can be site-constructed as a braced wall panel.

TYPICAL SHEATHING TRADEMARKS

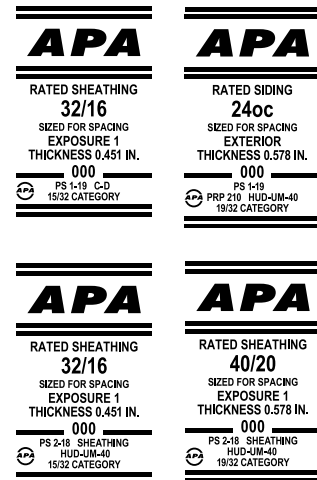
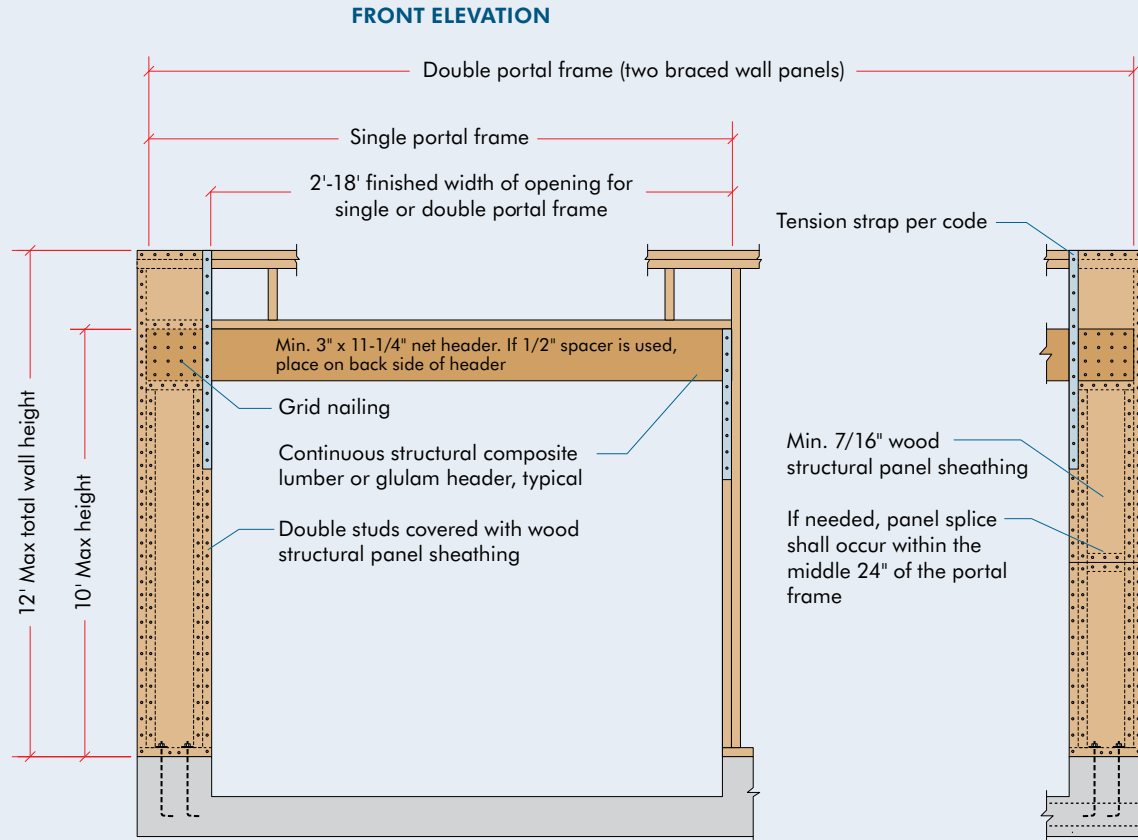

FIGURE 11

METHOD CS-PF—CONTINUOUSLY SHEATHED PORTAL FRAME WITHOUT HOLD-DOWNS

Simplified from Figure R602.10.6.4 of the 2018 IRC. For detailed requirements, see 2018 IRC.



For SI: 1 inch = 25.4 mm, 1 foot = 304.8 mm.

In a portal frame, the header extends past the opening and is tied to its wall segment by overlapping plywood or OSB to stiffen the joint. The panels are attached to the wall studs and to the header with closely spaced nails, and the sill is bolted to the foundation. See 2018 IRC Section 602.10.6.4 for complete code requirements. For more details, see *Technical Note: Portal Frame Bracing Without Hold-Down Devices*, Form J470.

APA's Wall Bracing Calculator is a free tool for experienced designers that generates a printed report showing IRC wall bracing compliance. The report's visual format provides a graphic representation of how IRC wall bracing requirements have been met, simplifying the approval process for builders and code officials. Access the calculator at www.apawood.org/calculator.

Shear Walls

The engineered version of wall bracing is a shear wall. Shear walls are designed by an engineer to resist the specific forces determined by engineering analysis. Shear walls have specific design values depending on their construction, fastener spacing, fastener size, sheathing thickness and framing species. Table 23 shows the allowable stress design values for single-sided sheathed wood structural panel shear walls. Shear walls are also permitted to be designed to account for openings and with both sides of the wall sheathed. They usually require hold-downs to resist overturning of wall segments, as shown in Figure 12. More information on designing

with shear walls is available in the APA publication *Design/Construction Guide: Diaphragms and Shear Walls*, Form L350.

The force transfer around openings (FTAO) method of shear wall analysis offers some advantages compared to other methods: More versatility, because the FTAO method allows for the use of narrower wall segments while meeting required height-to-width ratios, and a high likelihood that fewer hold-downs will be required. Visit www.apawood.org/ftao for more information and to access the FTAO calculator, an Excel-based tool for professional designers that uses FTAO methodology to calculate maximum hold-down force for uplift resistance, the required horizontal strap force for the tension straps above and below openings, the maximum shear force to determine sheathing attachment and the maximum deflection of the wall system.

Either APA RATED SHEATHING or all-veneer plywood APA RATED SIDING (and other APA RATED SIDING panels that qualify on a proprietary basis) can be used in shear wall design. The data presented here give maximum shears for walls with APA RATED SHEATHING, with plywood APA RATED SIDING installed directly to studs (APA Sturd-I-Wall), and with panels applied over gypsum sheathing for walls required to be fire-rated from the outside.

FIGURE 12

SHEAR WALL HOLD-DOWN ANCHOR

Shear wall overturning moments may be transferred by a fabricated steel bracket such as this. Regular foundation bolts may be all that is required in some cases depending on engineering analysis.

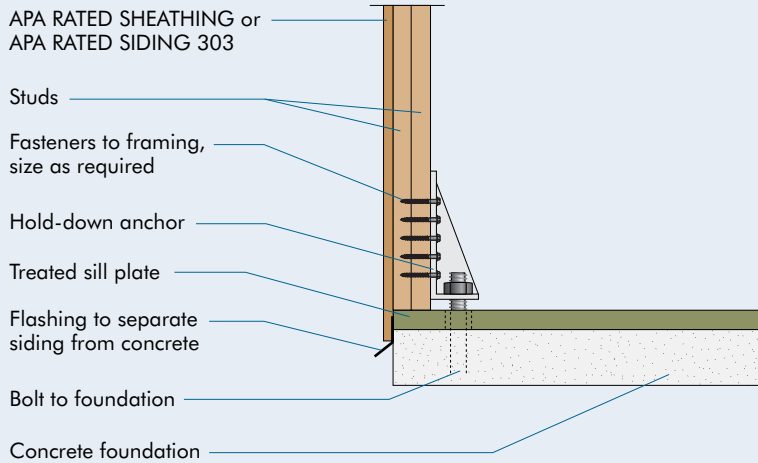

TABLE 23

ALLOWABLE SHEAR (POUNDS PER FOOT) FOR APA PANEL SHEAR WALLS WITH FRAMING OF DOUGLAS-FIR, LARCH OR SOUTHERN PINE^a FOR WIND^{b,c,d,e,f} OR SEISMIC^{c,d,e,g} LOADING

| Panel Grade | Minimum Nominal Panel Thickness (in.) | Minimum Nail Penetration in Framing (in.) | Panels Applied Direct to Framing | | | | Panels Applied Over 1/2" or 5/8" Gypsum Sheathing | | | | | | |
|--|---------------------------------------|---|---|-----------------------------------|------------------|------------------|---|--------------------------------------|-----------------------------------|-----|------------------|----------------|---|
| | | | Nail Size (common or galvanized box) ^h | Nail Spacing at Panel Edges (in.) | | | | Nail Size (common or galvanized box) | Nail Spacing at Panel Edges (in.) | | | | |
| | | | | 6 | 4 | 3 | 2 ⁱ | | 6 | 4 | 3 | 2 ⁱ | |
| APA STRUCTURAL I grades | 3/8 | | | 230 ^j | 360 ^j | 460 ^j | 610 ^j | | | | | | |
| | 7/16 | 1-3/8 | 8d | 255 ^j | 395 ^j | 505 ^j | 670 ^j | 10d | 280 | 430 | 550 ^j | 730 | |
| | 15/32 | | | 280 | 430 | 550 | 730 | | | | | | |
| | 15/32 | 1-1/2 | 10d | 340 | 510 | 665 ^j | 870 | | — | — | — | — | |
| APA RATED SHEATHING; APA RATED SIDING ^m and other APA grades except species Group 5 | 5/16 or 1/4 ^k | 1-1/4 | 6d | 180 | 270 | 350 | 450 | 8d | 180 | 270 | 350 | 450 | |
| | 3/8 | | | 200 | 300 | 390 | 510 | | 200 | 300 | 390 | 510 | |
| | 3/8 | | | 220 ^j | 320 ^j | 410 ^j | 530 ^j | | | | | | |
| | 7/16 | 1-3/8 | 8d | 240 ^j | 350 ^j | 450 ^j | 585 ^j | 10d | 260 | 380 | 490 ^j | 640 | |
| | 15/32 | | | 260 | 380 | 490 | 640 | | | | | | |
| | 15/32 | 1-1/2 | 10d | 310 | 460 | 600 ^j | 770 | — | — | — | — | — | — |
| APA RATED SIDING ^m and other APA grades except species Group 5 | 5/16 ^k | 1-1/4 | Nail Size (galvanized casing) 6d | 140 | 210 | 275 | 360 | Nail Size (galvanized casing) 8d | 140 | 210 | 275 | 360 | |
| | 3/8 | 1-3/8 | 8d | 160 | 240 | 310 | 410 | 10d | 160 | 240 | 310 ^j | 410 | |

- a. For framing of other species: (1) Find specific gravity for species of lumber in the AWC National Design Specification (NDS). (2) For common or galvanized box nails, find shear value from table above for nail size for actual grade. (3) Multiply value by the following adjustment factor: Specific Gravity Adjustment Factor = [1 - (0.5 - SG)], where SG = specific gravity of the framing. This adjustment shall not be greater than 1.
- b. For wind load applications, the values in the table above shall be permitted to be multiplied by 1.4.
- c. All panel edges backed with 2-inch nominal or wider framing. Install panels either horizontally or vertically. Space nails maximum 6 inches o.c. along intermediate framing members for 3/8-inch and 7/16-inch panels installed on studs spaced 24 inches o.c. For other conditions and panel thicknesses, space nails maximum 12 inches o.c. on intermediate supports. Fasteners shall be located 3/8 inch from panel edges.
- d. Where panels applied on both faces of a wall and nail spacing is less than 6 inches o.c. on either side, panel joints shall be offset to fall on different framing members, or framing shall be 3-inch nominal or thicker at adjoining panel edges and nails on each side shall be staggered.
- e. Galvanized nails shall be hot-dip or tumbled.
- f. For shear loads of normal or permanent load duration as defined by the NDS, the values in the table above shall be multiplied by 0.63 or 0.56 respectively.
- g. In Seismic Design Category D, E or F, where shear design values exceed 350 pounds per lineal foot, all framing members receiving edge nailing from abutting panel edges shall not be less than a single 3-inch nominal member, or two 2-inch nominal members fastened together to transfer the design shear value between framing members. Wood structural panel joint and sill plate nailing shall be staggered in all cases. See IBC or AWC *Special Design Provisions for Wind and Seismic (SDPWS)* for sill plate size and anchorage requirements.
- h. See Table 6, page 17, for nail dimensions.
- i. Framing at adjoining panel edges shall be 3-inch nominal or wider, and nails shall be staggered where nails are spaced 2 inches o.c. Check local code for variations of these requirements.
- j. Allowable shear values are permitted to be increased to values shown for 15/32-inch sheathing with same nailing provided: (1) studs are spaced a maximum of 16 inches on center, or (2) panels are applied with long dimension across studs.
- k. 3/8-inch or APA RATED SIDING 16 oc is minimum recommended when applied direct to framing as exterior siding.
- l. Framing at adjoining panel edges shall be 3-inch nominal or wider, and nails shall be staggered where 10d nails (3" x 0.148") having penetration into framing of more than 1-1/2 inches are spaced 3 inches o.c. Check local code for variations of these requirements.
- m. Values apply to all-veneer plywood APA RATED SIDING panels only. Other APA RATED SIDING panels may also qualify on a proprietary basis. APA RATED SIDING 16 oc plywood may be 11/32 inch, 3/8 inch or thicker. Thickness at point of nailing on panel edges governs shear values.

Typical Layout for Shear Walls

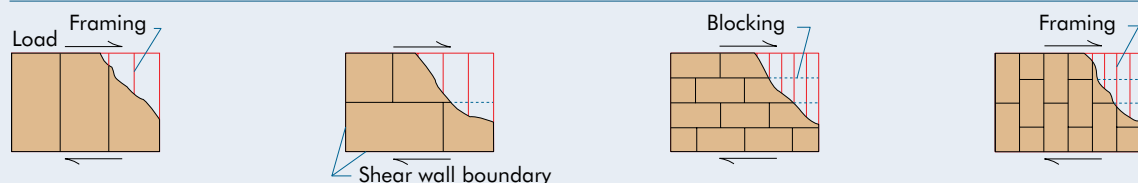

Designing for Combined Shear and Wind Uplift

Builders who are working to meet building code requirements for structural wall systems in high wind areas can find a straightforward solution with wood structural panels detailed in *APA System Report SR-101: Design for Combined Shear and Uplift from Wind*, Form SR-101. In addition to meeting the engineering and code requirements for shear and wind uplift, the system also delivers the benefits of fully sheathed construction, flexible design, durability and sustainability.

The system begins with a wood structural panel that is designed as a shear wall and has a specific attachment schedule associated with its desired shear capacity. To obtain additional uplift resistance from the panel, additional nails are added to the shear nailing at the top and bottom of the panel. These additional nails are used to transfer the uplift force from the top plate to the panel, from panel to panel at a splice location (if present) and from panel to sole plate at the foundation, effectively eliminating the need for uplift straps at these locations. Uplift straps will still be required around window and door openings in the exterior walls to transfer the uplift loads acting on the header to the foundation below. Since the total number of straps is reduced, however, the builder saves time and money and does not have to work around as many straps when fastening other elements of the structure, such as shear wall hold-downs and siding.

One of the factors that makes this design system simple and easy to use is the high shear capacity of wood structural panels. Because of the limitations of nailed connections in lumber, only a small fraction of the panel shear capacity is actually used in a shear wall. While it is true that putting a panel in tension reduces its shear capacity, there is sufficient residual shear capacity left to permit the panels to be used in combined shear and uplift.

See *APA System Report SR-101* for detailed information.

Advanced Framing

“Advanced framing” refers to a suite of framing techniques that increase energy efficiency and optimize the use of building materials, reducing waste and cost for builder and homeowner alike. Advanced framing techniques include using 2x6 wood studs placed 24 inches on center with wood structural panel wall sheathing, designing corners and intersecting walls with insulated spaces and using headers that provide space for insulation; see Figure 13. These framing techniques can increase the energy efficiency of homes. The most common advanced framing techniques require little in the way of new skills or additional cost.

FIGURE 13

WALL FRAME COMPARISON

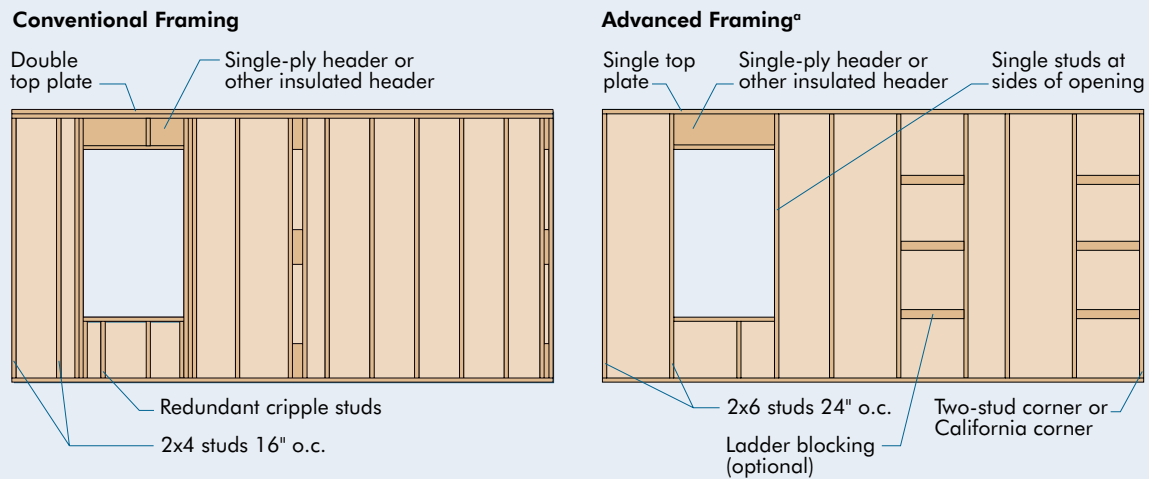

Conventional framing typically consists of 2x4 or 2x6 wood framing spaced 16 inches on center, three-stud corners, multiple jack studs, double or triple headers, redundant cripple studs and unnecessary framing members.

Advanced framing typically includes 2x6 wood framing spaced at 24 inches on center, insulated corner junctions, minimal use of jack studs and cripples and the elimination of redundant framing and blocking. Correctly sized headers are used over openings in load-bearing walls; simple non-load-bearing headers are used in non-load-bearing walls, where applicable.

Advanced framing boosts whole wall R-value (resistance to heat flow) by maximizing space for cavity insulation. When 2x6 framing is used with double top plates, there is no need to vertically align framing members.

Consult APA’s *Advanced Framing Construction Guide*, Form M400, for further information on advanced framing techniques.

APA Sheathing Under Stucco

Greater stiffness is recommended for wall sheathing when stucco is to be applied. To increase stiffness, apply the long panel dimension or strength axis across studs. See Figure 14. Blocking or a plywood cleat is recommended at horizontal joints. Blocking is required for shear wall and wall bracing applications. For recommendations on panels applied horizontally or vertically, see Table 24.

FIGURE 14

STUCCO OVER APA PANEL SHEATHING

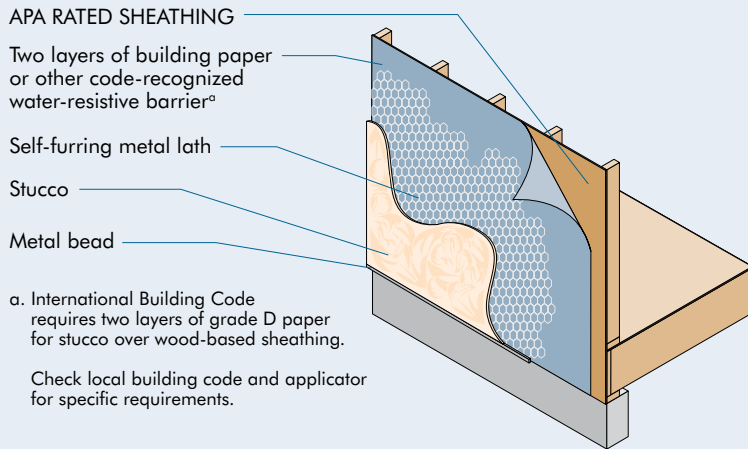

TABLE 24

RECOMMENDED THICKNESS AND SPAN RATING FOR APA PANEL WALL SHEATHING FOR STUCCO EXTERIOR FINISH

| Stud Spacing (in.) | Panel Orientation ^a | APA Rated Sheathing ^b | |
|--------------------|--------------------------------|----------------------------------|---------------------|
| | | Minimum Performance Category | Minimum Span Rating |
| 16 | Horizontal ^c | 3/8 | 24/0 |
| | Vertical | 7/16 ^d | 24/16 |
| 24 | Horizontal ^c | 7/16 | 24/16 |
| | Vertical | 19/32 ^e | 40/20 |

- a. Strength axis (typically the long panel dimension) perpendicular to studs for horizontal application; or parallel to studs for vertical application.
- b. Recommendations apply to plywood or oriented strand board (OSB) except as noted.
- c. Blocking recommended between studs along horizontal panel joints.
- d. Structural I Rated Sheathing (OSB).
- e. OSB or 5-ply/5-layer plywood.

Wood Structural Panel Sheathing as a Nail Base for Siding and Trim

Wood structural panel sheathing provides a withdrawal-resistant nail base for the attachment of exterior wall finishes. Table 25 is a guide for using sheathing as a nail base with lightweight claddings. Popular lightweight cladding products include vinyl, wood, aluminum, fiber cement, APA-Rated lap and panel siding, wood shingles/shakes and synthetic stucco products. For claddings with weights of 3 psf or less, substituting ring-shank nails for smooth-shank nails allows the same fastener spacing for attachment to continuous wood structural panel sheathing as the siding manufacturer's recommendations for attachment to studs.

TABLE 25

OPTIONAL SIDING ATTACHMENT SCHEDULE FOR FASTENERS WHERE NO STUD PENETRATION NECESSARY

| Application | Number and Type of Fastener | Spacing of Fasteners ^b |
|---|--|-----------------------------------|
| Exterior wall covering (weighing 3 psf or less) attachment to wood structural panel sheathing, either direct or over foam sheathing a maximum of 2 inches thick. ^a | Ring-shank roofing nail (0.120" min. dia.) | 12" o.c. |
| | Ring-shank nail (0.148" min. dia.) | 15" o.c. |
| | No. 6 screw (0.138" min. dia.) | 12" o.c. |
| | No. 8 screw (0.164" min. dia.) | 16" o.c. |

For SI: 1 inch = 25.4 mm, 1 pound per square foot = 0.479 kPa.

- Fastener length shall be sufficient to penetrate the back side of the wood structural panel sheathing by at least 1/4 inch. The wood structural panel sheathing shall be not less than 7/16 inch in thickness.
- Spacing of fasteners is per 12 inches of siding width. For other siding widths, multiply "Spacing of Fasteners" above by a factor of 12/s, where "s" is the siding width in inches. Fastener spacing shall never be greater than the manufacturer's minimum recommendations.

Siding products with weights exceeding 3 psf require additional consideration when fastening directly to sheathing. Consult *Technical Topics: Wood Structural Panels Used as Nailable Sheathing*, Form TT-109, for more information, including the withdrawal resistance for a number of different fastener types (smooth-, ring- and screw-shank nails; wood screws; and vinyl siding nails). Used in combination with the wind load tables R301.2(2) and R301.2(3) from the 2012, 2015 and 2018 IRC, the attachment schedules for any combination of siding type, design wind speed and exposure can be determined using APA Technical Topic TT-109.

Note: In addition to panel edge spacing and the use of straight studs, nailing sequence can also be a factor in maintaining a uniformly flat appearance of the finished wall. Installation procedure: First, position the panel, maintaining recommended edge spacing, and lightly tack at each corner. Install the first row of nails at the edge next to the preceding panel from top to bottom. Remove remaining tacking nails. Then nail the row at the first intermediate stud. Continue by nailing at the second intermediate stud, and finally, at the edge opposite the preceding panel. Complete the installation by fastening to the top and bottom plates.

APA Sturd-I-Wall®

The APA Sturd-I-Wall system consists of APA RATED SIDING (panel or lap) applied direct to studs or over nonstructural fiberboard, gypsum or rigid foam insulation sheathing^a. Nonstructural sheathing is defined as sheathing not recognized by building codes for meeting both bending and racking strength requirements.

A single layer of wood structural panel siding, since it is strong and rack resistant, eliminates the cost of installing separate structural sheathing or diagonal wall bracing. Panel sidings are normally installed vertically, but may also be placed horizontally (long dimension across supports) if horizontal joints are blocked. Maximum stud spacings for both applications are given in Tables 26, 27, 28 and 29.

When installing panel or lap siding over rigid foam insulation sheathing, drive the nails flush with the siding surface, but avoid over-driving, which can result in dimpling of the siding due to the compressible nature of foam sheathing.

Sidings are occasionally treated with water repellents or wood preservatives to improve finishing characteristics or moisture resistance for certain applications. If the siding has been treated, allowing the surface treatment to dry will avoid solvent or chemical reaction with the foam sheathing.

FIGURE 15

APA STURD-I-WALL (Vertical Panel Installation)

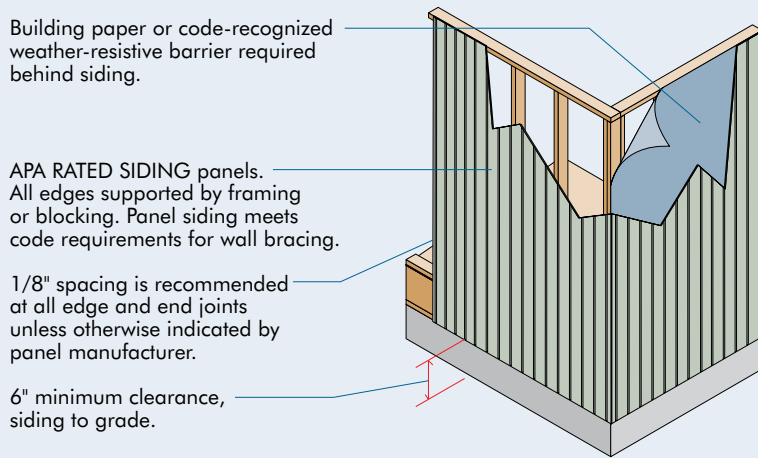
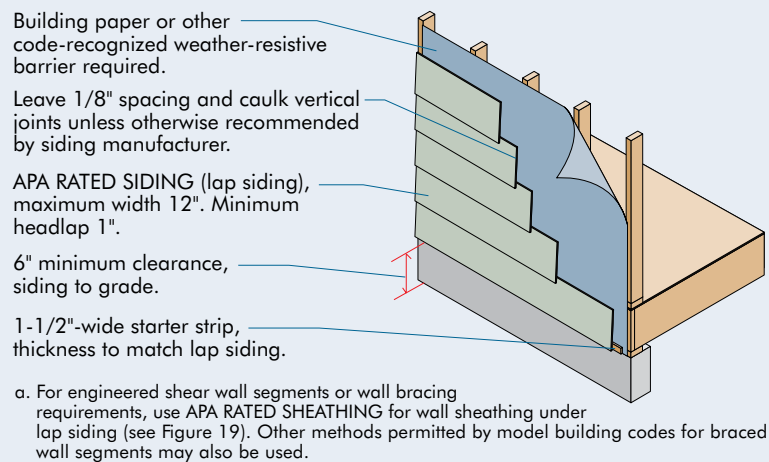
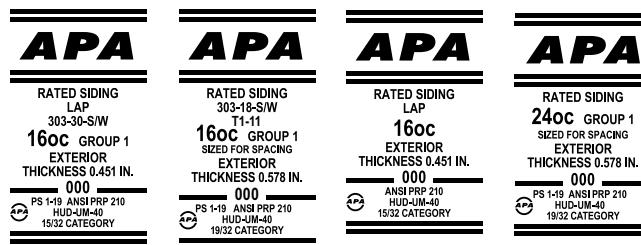

FIGURE 16

APA STURD-I-WALL (Horizontal Lap Siding Installation)^a



TYPICAL SIDING TRADEMARKS



a. Where panel siding is applied over foam sheathing, see APA publication *APA Rated Siding Panels over Rigid Foam Insulation Sheathing*, Form C465.

All panel siding edges in Sturd-I-Wall construction should be backed with framing or blocking. Use nonstaining, noncorrosive nails as described in Tables 26, 27, 28 and 29 to prevent staining the siding.

Where siding is to be applied at an angle, install only over wood structural panel sheathing.

Note: Gluing of siding to framing is not recommended due to the increased potential for panel buckling.

TABLE 27

APA RATED LAP SIDING APPLIED DIRECT-TO-STUDS OR OVER NONSTRUCTURAL SHEATHING^{a,b,c,d,e}

| Minimum Nail | | Minimum Performance Category (in.) | Wall Stud Spacing (in. o.c.) | Lap Siding Width (in.) | Ultimate Design Wind Speed (mph) | | |
|----------------------|------------------------------|------------------------------------|------------------------------|------------------------|----------------------------------|-----|-----|
| Shank Diameter (in.) | Penetration in Framing (in.) | | | | Wind Exposure Category | | |
| | | | | | B | C | D |
| 0.113 | 1.5 | 3/8 | 16 | 6 | 180 | 155 | 140 |
| | | | | 8 | 180 | 155 | 140 |
| | | | | 12 | 155 | 130 | 115 |
| | | 7/16 | 16 | 6 | 180 | 155 | 140 |
| | | | | 8 | 180 | 155 | 140 |
| | | | | 12 | 155 | 130 | 115 |
| | 7/16 | 24 | 6 | 180 | 155 | 140 | |
| | | | 8 | 155 | 130 | 115 | |
| | | | 12 | 115 | NP | NP | |

- a. Table is based on wind pressures acting toward and away from building surfaces, at 30-ft height in wall Zone 5 (corners) with smallest effective area, per Chapter 30 of ASCE 7-16 and Section R301.2 of the 2018 IRC. Stud specific gravity = 0.42.
- b. Recommendations of siding manufacturer may vary.
- c. APA Rated lap siding rated 16 oc and 24 oc shall be used with a maximum stud spacing of 16 inches o.c. and 24 inches o.c., respectively.
- d. Hot-dip galvanized nails are recommended for most siding applications. See Siding Fasteners section of page 72 for more information.
- e. Single nail at each intermediate stud. Double nail at studs with abutting lap siding. Locate nail 3/8 inch from top of lap siding edge.
- f. Supported panel joints shall occur approximately along the centerline of framing with a minimum bearing of 1/2 inch. Fasteners shall be located 3/8 inch from panel edges. Siding installed over two or more spans.
- g. See Table 6, page 17, for nail dimensions.

TABLE 28

MAXIMUM STUD SPACING: APA RATED SIDING (PANEL) APPLIED DIRECT-TO-STUDS OR STRUCTURAL SHEATHING

| Siding Description | Minimum Performance Category or Span Rating | Maximum Stud Spacing (in.) for Vertical Rows of Nails | |
|--------------------|---|---|---------------------------|
| | | Parallel to Supports | Perpendicular to Supports |
| APA MDO GENERAL | 3/8 | 16 | 24 |
| | 15/32 | 24 | 24 |
| APA RATED SIDING | 16 oc | 16 | 16 ^a |
| | 24 oc | 24 | 24 |

- a. Stud spacing may be 24 inches o.c. for veneer-faced siding panels.

TABLE 29

APA RATED SIDING (PANEL) APPLIED TO NAIL BASE SHEATHING^{a,b,c,d,e}

| APA Rated Panel Siding | Minimum Nail ^{f,g} | | Panel Nail Spacing | | Ultimate Design Wind Speed (mph) | | |
|--|-----------------------------|------------------------------|-------------------------------|----------------------------------|----------------------------------|-----|-----|
| | Shank Diameter (in.) | Wall Stud Spacing (in. o.c.) | Edges ^h (in. o.c.) | Intermediate Supports (in. o.c.) | Wind Exposure Category | | |
| | | | | | B | C | D |
| 3/8 Performance Category APA MDO GENERAL APA Rated Siding 16 oc or 24 oc | 0.120 ring shank | 16 | 6 | 12 | 140 | 115 | 110 |
| | | | | 6 | 160 | 135 | 115 |
| | | 24 | 6 | 12 | 115 | NP | NP |
| | | | | 6 | 140 | 90 | 110 |

- a. Table is based on wind pressures acting toward and away from building surfaces, at 30-ft height in wall Zone 5 (corners) with smallest effective area, per Chapter 30 of ASCE 7-16 and Section R301.2 of the 2018 IRC, stud specific gravity = 0.42.
- b. Recommendations of siding manufacturer may vary.
- c. For use as wood structural panel wall bracing, the minimum fastener spacing of 6 inches o.c. at panel edges and 12 inches o.c. at intermediate supports shall be sufficient.
- d. Hot-dip galvanized nails are recommended for most siding applications. See Siding Fasteners section on page 72 for more information.
- e. Maximum stud spacing shall be in accordance with Table 28.
- f. Ring-shank nail shall be used.
- g. See Table 6, page 17, for nail dimensions.
- h. Supported panel joints shall occur approximately along the centerline of framing with a minimum bearing of 1/2 inch. Fasteners shall be located 3/8 inch from panel edges.

TABLE 30

APA RATED LAP SIDING APPLIED DIRECTLY TO STUDS OR TO NAIL BASE SHEATHING^{a,b,c}

| Minimum Nail Shank Diameter ^d (in.) | Minimum Performance Category Lap Siding | Fastener Spacing (in.) ^e | Lap Siding Width (in.) | Ultimate Design Wind Speed (mph) | | |
|--|---|-------------------------------------|------------------------|----------------------------------|-----|-----|
| | | | | B | C | D |
| 0.113 | 3/8 | 6 | 6 | 170 | 140 | 130 |
| | | | 8 | 140 | 115 | 110 |
| | | | 12 | 110 | NP | NP |

- a. Table is based on wind pressures acting toward and away from building surfaces, at 30-ft height in wall Zone 5 (corners) with smallest effective area, per Chapter 30 of ASCE 7-16 and Section R301.2 of the 2018 IRC, stud specific gravity = 0.42.
- b. Recommendations of siding manufacturer may vary.
- c. Hot-dip galvanized nails are recommended for most siding applications. See Siding Fasteners section on page 72 for more information.
- d. See Table 6, page 17, for nail dimensions.
- e. Fastener spacing at top edge of lap siding.

Siding Fasteners

Hot-dip galvanized nails are recommended for most siding applications. For best performance, stainless steel or aluminum nails should be considered. APA tests also show that electrically or mechanically galvanized steel nails appear satisfactory when plating meets or exceeds thickness requirements of ASTM A641 Class 2 coatings, and when nails are further protected by yellow chromate coating. Galvanized fasteners may react under wet conditions with the natural extractives of some wood species and may cause staining if left unfinished. Such staining can be minimized if the siding is finished in accordance with APA recommendations, or if the roof overhang protects the siding from direct exposure to moisture and weathering.

FIGURE 18

APA RATED PANEL SIDING OVER WOOD STRUCTURAL PANEL SHEATHING

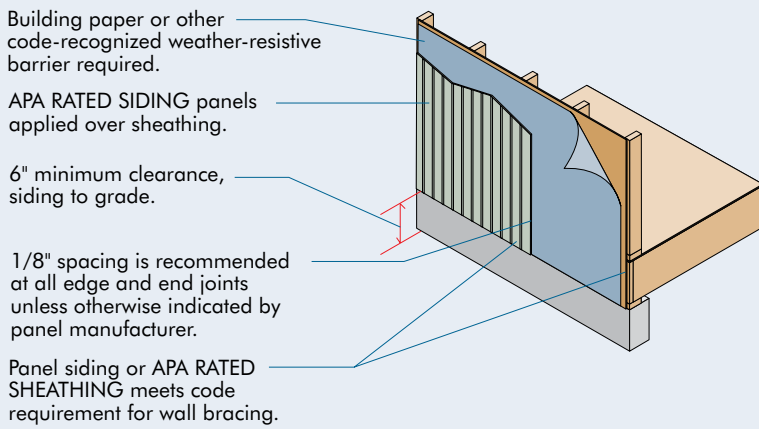

FIGURE 19

APA RATED LAP SIDING OVER WOOD STRUCTURAL PANEL SHEATHING

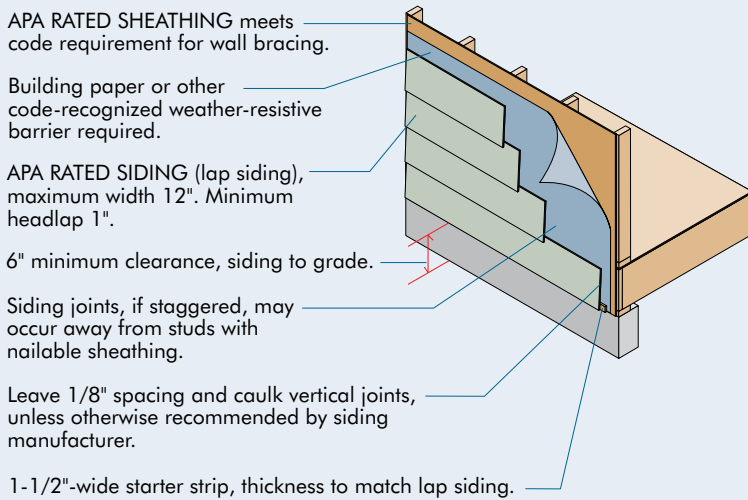

FIGURE 20

TYPICAL PANEL SIDING JOINT DETAILS

Note: Water-resistive barrier (building paper or house wrap omitted from figure for clarity) is required behind siding.

VERTICAL WALL JOINTS

Butt

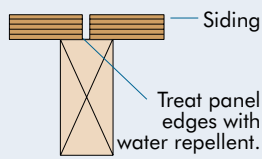

Shiplap

Reverse Board and Batten

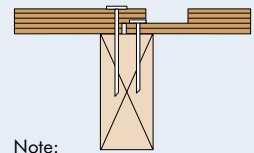

T1-11 & Channel Groove

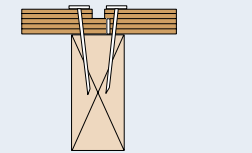

Note: Nailing of both panel edges along shiplap joint is recommended. The "double nailing" is required when wall segment must meet wall bracing or engineered shear wall requirements.

Vertical Batten

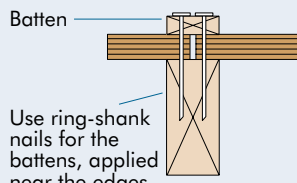

Use ring-shank nails for the battens, applied near the edges in two staggered rows.

VERTICAL INSIDE & OUTSIDE CORNER JOINTS

Butt & Caulk

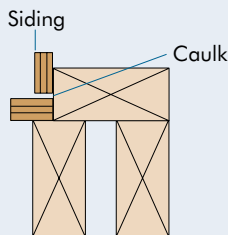

Corner Board Lap Joints

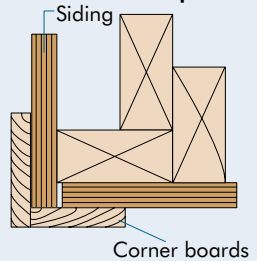

Lap Siding (APA Sturd-I-Wall)

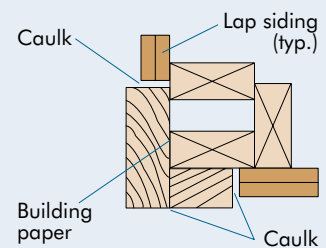
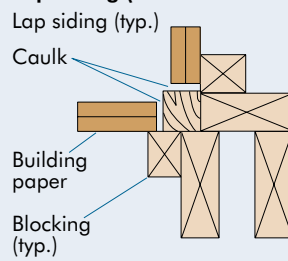

HORIZONTAL WALL JOINTS

Butt & Flash

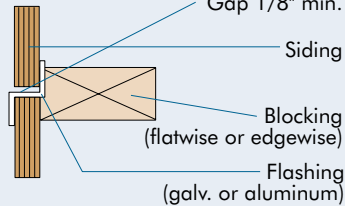

Lap

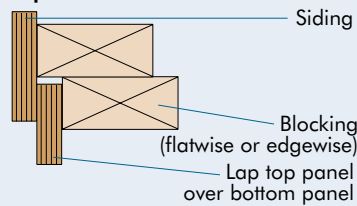

Shiplap

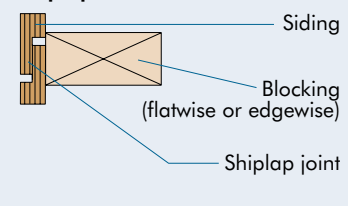

HORIZONTAL BELTLINE JOINTS

(For multistory buildings, when conventional lumber floor joists and rim boards are used, make provisions at horizontal joints for shrinkage of framing, especially when applying siding direct to studs.)

Jog Exterior Stud Line

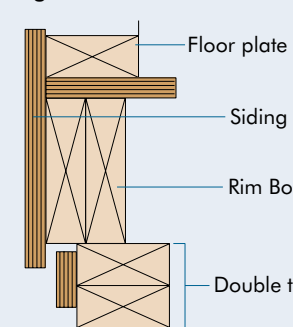

Band Board Over Panel Filler

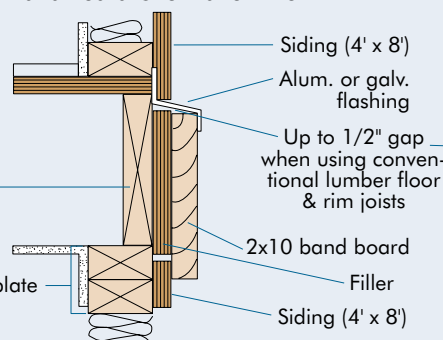

Band Board In Relief

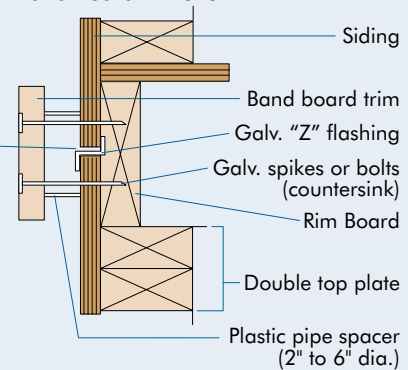

WINDOW DETAILS

(For window details, see *Build A Better Home: Walls*, Form A530.)

Siding Joint Details

The siding joint details in Figure 20 are based on the use of APA trademarked siding. Nailing of wood structural panel siding along both edges of shiplap joints (“double nailing”), as shown, is required for shear walls or those wall segments that must meet bracing requirements. Double nailing is recommended for all other applications as well to provide maximum wall strength and moisture protection.

Where caulks or joint sealants are indicated, consider the various types available such as urethane, plasticized acrylic latex, butyl and polysulfide. Check with the manufacturer of the caulk or sealant to determine suitability for the intended application and compatibility with coatings and other building materials such as vinyl and aluminum.

In some cases, a foam backer rod or other type filler material may be used behind the sealants as recommended by the manufacturer. For best results in other cases, apply caulking to framing at panel edges before installing the siding panel; or apply a bead of caulk along the panel edge before installing the next panel. A 1/8-inch space is recommended at all edge and end joints unless otherwise indicated by panel manufacturer. If caulk is to be used, also check with caulk manufacturer for recommended edge spacing. Nails through battens or other wood trim must penetrate at least 1 inch into studs. Nail panel siding 6 inches o.c. along edges and 12 inches o.c. at intermediate supports. To prevent staining of siding, use hot-dip galvanized, aluminum or other nonstaining nails as described on page 72.

Siding is often fully exposed to weather and thus has increased susceptibility to elevated moisture conditions. Although siding will periodically experience moisture contents above the threshold value needed to support decay, wood-based siding products have a good history of performance because they dry below this threshold value before decay can initiate. If trim is installed around siding, be sure that it doesn't trap moisture or reduce the drying ability of the wood. Trim that is applied incorrectly can lead to long-term moisture accumulation that causes decay.

Apply flashing or other means of protection over end grain of siding to minimize water absorption.

APA Rated Siding Patterns and Grades

APA RATED SIDING, including 303 plywood siding, is available in a wide variety of surface textures and patterns. For descriptions of siding surface patterns and thicknesses, refer to *APA Product Guide: Performance Rated Siding*, Form E300.

Actual dimensions of groove spacing, width and depth may vary with the manufacturer. Where the characteristics of a particular wood species are desired, specify by grade and species preference.

In order to help specifiers select the most appropriate siding appearance for any particular job, APA 303 plywood sidings are also identified by a face grading system. There are four basic siding classifications within the system—Special Series 303, 303-6, 303-18 and 303-30. Each class, as shown in Table 31, is further divided into grades according to categories of repair and appearance characteristics.

Finishing Plywood for Exterior Exposure

Care and Preparation

Plywood should be stored and handled with care to avoid damaging before finishing. Storage in a cool, dry place out of sunlight and weather is best. If left outdoors, straps on bundles should be loosened or cut and the plywood covered. Allow good air circulation to prevent moisture condensation and possible mold growth.

Edge Sealing

Moisture enters the end grain of plywood or other wood-based products faster than through the surface. Consequently, edges and ends of APA RATED SIDING panels or lap siding should be sealed. Although edge sealers are not necessarily moisture-proof or permanently durable, they help to minimize sudden changes in moisture content in the siding due to weather.

APA RATED SIDING may be edge-sealed at the factory. If the siding is not factory-sealed, it can be sealed quickly at the job site while the panels or lap siding pieces are still in a stack. Edges or ends cut during construction should be resealed.

Siding to be finished with a semitransparent or solid-color stain can be edge-sealed with a liberal application of a paintable, water-repellent sealer. If the siding is to be painted, apply sealer to edges using the same paint primer that will be used on the surface. Horizontal edges, particularly lower drip edges of siding, should be carefully edge-sealed because of their greater wetting exposure.

TABLE 31

APA 303 SIDING FACE GRADES^a

| 303 Series Plywood Siding Grades | Type of Patch | |
|--|-----------------------------|-----------------------------------|
| | Wood | Synthetic |
| 303-OC | Not permitted | Not permitted |
| 303-OL | Not applicable for overlays | |
| 303-NR | Not permitted | Not permitted |
| 303-SR | Not permitted | Permitted as natural-defect shape |
| 303-6-W | Limit 6 | Not permitted |
| 303-6-S | Not permitted | Limit 6 |
| 303-6-S/W | Limit 6—any combination | |
| 303-18-W | Limit 18 | Not permitted |
| 303-18-S | Not permitted | Limit 18 |
| 303-18-S/W | Limit 18—any combination | |
| 303-30-W | Limit 30 | Not permitted |
| 303-30-S | Not permitted | Limit 30 |
| 303-30-S/W | Limit 30—any combination | |

a. All panels except 303-NR allow restricted minor repairs such as shims. These other face appearance characteristics as knots, knotholes, splits, etc., are limited by both size and number in accordance with panel grades, 303-OC being most restrictive and 303-30 being least. Multiple repairs are permitted only on 303-18 and 303-30 panels. Patch size is restricted on all panel grades.

Finishing

APA RATED SIDING may be finished with a variety of products such as semitransparent stains, solid-color stains or paint systems. The recommended finishes depend on the type of siding product and whether it has an overlaid surface.

Oil-based, semitransparent stains may be used on certain veneer-faced siding products as detailed in Table 32. Solid-color stains may be used on most APA RATED SIDING products and usually provide better protection. In general, however, best overall performance on APA RATED SIDING products can be achieved with an all-acrylic latex paint system.

For overlaid siding, any top-quality exterior house paint system formulated for wood performs satisfactorily. Solid-color stains may also be used on overlaid sidings, although some manufacturers recommend only acrylic latex formulations. For specific recommendations on finishing OSB siding products, consult the siding manufacturer.

Table 32 provides a summary of finishing recommendations for APA 303 Siding face grades. For complete information, refer to *APA Product Guide: Performance Rated Siding*, Form E300.

Semitransparent Stains (oil-based only)

Oil-based semitransparent stains emphasize grain patterns, texture and natural characteristics in the wood. They may be used on plywood face grades 303-OC, 303-NR and 303-6-W. It is the only finish recommended for use over brushed plywood. Other 303 face grades should not be finished with semitransparent stains unless specifically recommended by the panel manufacturer.

Solid-Color Stains (oil or all-acrylic latex)

An opaque or solid-color stain obscures color differences in the wood and between repairs and surrounding wood. This is often a satisfactory finishing system, therefore, where semitransparent stains are unsuitable. Wood grain is also muted with solid-color stains, but wood surface textures usually remain evident. When in question, the finish should be applied to a representative sample in order to demonstrate the finished appearance.

Solid-color stains are particularly recommended for grades 303-6-S and 303-6-S/W, as well as 303-18 and 303-30 with any type of patch.

TABLE 32

APA 303 SIDING FINISHING RECOMMENDATIONS

| 303 Series Plywood Siding Grades | Stains | | Paints |
|--|--------------------------|--|--|
| | Semitransparent (oil) | Solid Color (oil or latex) ^a | Minimum 1 primer plus 1 topcoat (acrylic latex) |
| 303-OC | b | b | b |
| 303-OL | Not Recommended | d | b |
| 303-NR | b | e | e |
| 303-SR | c | e | e |
| 303-6-W | b | b | b |
| 303-6-S | c | b | b |
| 303-6-S/W | c | b | b |
| 303-18-W | c | b | b |
| 303-18-S | c | b | b |
| 303-18-S/W | c | b | b |
| 303-30-W | c | b | b |
| 303-30-S | c | b | b |
| 303-30-S/W | c | b | b |

- Except for overlaid panels, use a stain-resistant primer with light-colored latex stains, since the wood extractives may cause a discoloration of the finish.
- Recommended with provisions given in text.
- Should not be finished with semitransparent stain unless specifically recommended by the panel manufacturer.
- Some panel manufacturers recommend only acrylic latex formulations. Consult the manufacturer's recommendations.
- Only acrylic latex formulations are recommended when solid-color stains or paint systems are applied over open voids.

Paints (all-acrylic latex)

Top-quality acrylic latex house paint systems are recommended for all APA Rated Siding except brushed plywood. If house paint is used on plywood siding, an all-acrylic latex paint system consisting of at least one stain-blocking primer coat and an all-acrylic latex topcoat is recommended. For extractive staining woods, some house paint systems utilize an oil-alkyd primer. Others use up to two coats of a stain-blocking acrylic latex primer. These latter systems help to reduce face-checking and generally offer superior performance. A paint finish tends to mask the textured plywood surface more than either semitransparent or solid-color stains. On the other hand, a top-quality acrylic latex paint system provides the most durable finish.

Grade 303-OL may be finished with any top-quality exterior paint system—primer and companion topcoat—formulated for wood.

Field Application of Finish

Proper surface preparation is important for good performance of finishes on any surface. Remove dirt and loose wood fibers with a stiff nonmetallic bristle brush. Mildew may be removed with a solution of 1/4 part household bleach to 3/4 part warm water. Be sure to rinse thoroughly after application of bleach.

Finishes should be applied as soon as possible after installation of the siding. Weathering of unprotected wood can cause surface damage in as little as two to four weeks. Apply finishes during favorable weather conditions. As a rule of thumb, finishes should not be applied when the outside air temperature is expected to drop below 50° F within 24 hours for latex finishes, or 40° F for oil-based finishes. However, recommendations of individual manufacturers may vary and should always be followed. Wood surfaces should be clean and dry, although extremely dry surfaces should be dampened slightly when applying latex finishes.

Use only top-quality finishes and application equipment. Finishes should be applied according to the spread rates recommended by the manufacturer. Textured surfaces may require up to twice as much finish as smooth surfaces. The first coat should be applied by brush. If spray equipment is used to apply the finish, then the finish should be either back-brushed or back-rolled while it is still wet. Subsequent coats of finish may be applied by any conventional means.



ROOF CONSTRUCTION

APA Panel Roof Sheathing

Roof construction details using APA wood structural panels are illustrated in Figure 21. The recommendations for roof sheathing in Table 33 apply to APA RATED SHEATHING Exposure 1 or Exterior, APA STRUCTURAL I RATED SHEATHING Exposure 1 or Exterior and APA RATED STURD-I-FLOOR Exposure 1 or Exterior. Uniform load deflection limits are 1/180 of span under live load plus dead load, and 1/240 of span under live load only. Special conditions, such as heavy concentrated loads, may require constructions in excess of these minimums, or allowable live loads may have to be decreased for dead loads greater than 10 psf, such as tile roofs. Panels are assumed continuous over two or more spans with the long dimension or strength axis across supports.

Good performance of built-up, single-ply or modified bitumen roofing applied on low slope roofs requires a stiffer deck than does prepared roofing applied on pitched roofs. Although APA span-rated panels used as roof sheathing at maximum span are adequate structurally, an upgraded system is recommended for low slope roofs. Table 34 provides recommended maximum spans for low-slope roof decks.

Recommended live loads can be determined from Table 33 and minimum fastener requirements are given in Table 35. Increased nail schedules may be required in high wind zones. Recommended nail schedules for high wind zones are described in *APA Data File: Roof Sheathing Fastening Schedules for Wind Uplift*, Form T325.

FIGURE 21

APA PANEL ROOF SHEATHING

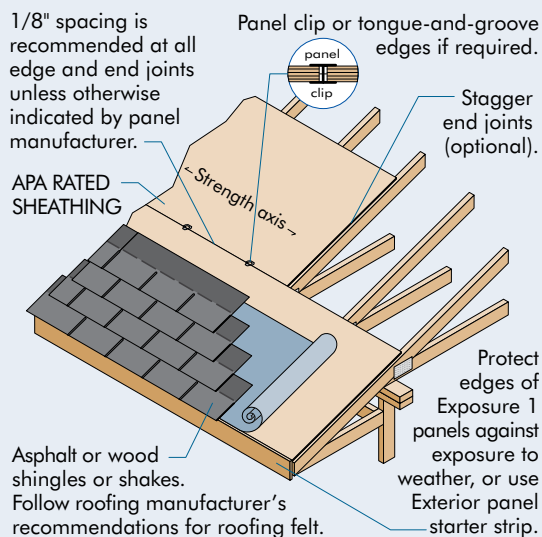

Notes:

1. Cover sheathing as soon as possible with roofing felt for extra protection against excessive moisture prior to roofing application.
2. For pitched roofs, place screened surface or side with skid-resistant coating up if OSB panels are used. Keep roof surface free of dirt, sawdust and debris, and wear skid-resistant shoes when installing roof sheathing.
3. For buildings with conventionally framed roofs (trusses or rafters), limit the length of continuous sections of roof area to 80 feet maximum during construction to allow for accumulated expansion in wet weather conditions. Omit roof sheathing panels in each course of sheathing between sections and install "fill in" panels later to complete roof deck installation prior to applying roofing.

TABLE 33

RECOMMENDED UNIFORM ROOF LIVE LOADS FOR APA RATED SHEATHING^a AND APA RATED STURD-I-FLOOR WITH STRENGTH AXIS PERPENDICULAR TO SUPPORTS^b

| Panel Span Rating | Minimum Panel Performance Category | Maximum Span (in.) | | Allowable Live Loads (psf) ^d | | | | | | | | |
|--------------------------------------|------------------------------------|--------------------------------|----------------------|--|-----|-----|-----|-----|-----|----|----|--|
| | | With Edge Support ^c | Without Edge Support | Spacing of Supports Center-to-Center (in.) | | | | | | | | |
| | | | | 12 | 16 | 20 | 24 | 32 | 40 | 48 | 60 | |
| APA RATED SHEATHING ^a | | | | | | | | | | | | |
| 24/0 | 3/8 | 24 | 19.2 ^e | 190 | 100 | 60 | 30 | | | | | |
| 24/16 | 7/16 | 24 | 24 | 190 | 100 | 65 | 40 | | | | | |
| 32/16 | 15/32 | 32 | 28 | 300 | 165 | 110 | 65 | 30 | | | | |
| 40/20 | 19/32 | 40 | 32 | — | 275 | 195 | 120 | 60 | 30 | | | |
| 48/24 | 23/32 | 48 | 36 | — | — | 270 | 175 | 95 | 45 | 30 | | |
| APA RATED STURD-I-FLOOR ^f | | | | | | | | | | | | |
| 20 oc | 19/32 | 32 | 32 | 270 | 150 | 100 | 60 | 30 | | | | |
| 24 oc | 23/32 | 48 | 36 | — | 240 | 160 | 100 | 50 | 30 | 20 | | |
| 32 oc | 7/8 | 48 | 40 | — | — | 295 | 185 | 100 | 55 | 35 | | |
| 48 oc | 1-3/32 | 60 | 48 | — | — | — | 290 | 160 | 100 | 65 | 40 | |

- a. Includes APA RATED SHEATHING/CEILING DECK.
- b. Applies to APA RATED SHEATHING and APA RATED STURD-I-FLOOR panels 24 inches or wider applied over two or more spans.
- c. Tongue-and-groove edges, panel edge clips (one midway* between each support, except two equally spaced between supports 48 inches on center or greater), lumber blocking or other. For low slope roofs, see Table 34.
*No established tolerance.
- d. 10 psf dead load assumed.
- e. 19.2 inches for Performance Category 3/8 and 7/16 panels. 24 inches for Performance Category 15/32 and 1/2 panels.
- f. Also applies to C-C Plugged grade plywood.

TABLE 34

RECOMMENDED MAXIMUM SPANS FOR APA PANEL ROOF DECKS FOR LOW-SLOPE ROOFS^a (Panel strength axis perpendicular to supports and continuous over two or more spans)

| Grade | Min. Panel Performance Category | Min. Span Rating | Max. Span (in.) | Panel Clips Per Span ^b (number) |
|-------------------------|---------------------------------|------------------|-----------------|--|
| APA RATED SHEATHING | 15/32 | 32/16 | 24 | 1 |
| | 19/32 | 40/20 | 32 | 1 |
| | 23/32 | 48/24 | 48 | 2 |
| APA RATED STURD-I-FLOOR | 19/32 | 20 oc | 24 | 1 |
| | 23/32 | 24 oc | 32 | 1 |
| | 7/8 | 32 oc | 48 | 2 |

- a. Low slope roofs are applicable to built-up, single-ply and modified bitumen roofing systems. For guaranteed or warranted roofs, contact membrane manufacturer for acceptable deck. Low-slope roofs have a slope that is less than 2/12 (2"/foot).
- b. Edge support may also be provided by tongue-and-groove edges or solid blocking.

TABLE 35

RECOMMENDED MINIMUM FASTENING SCHEDULE FOR APA PANEL ROOF SHEATHING (Increased nail schedules may be required in high wind zones and where roof is engineered as a diaphragm.)

| Panel Performance Category ^c | Size ^d | Nailing ^{a,b} Maximum Spacing (in.) | |
|---|-------------------|--|-----------------|
| | | Supported Panel Edges ^e | Intermediate |
| 3/8 – 1 | 8d | 6 | 12 ^f |
| 1-1/8 | 8d or 10d | 6 | 12 ^f |

- a. Use common smooth or deformed shank nails for panels with Performance Category 1 or smaller. For 1-1/8 Performance Category panels, use 8d ring- or screw-shank or 10d common smooth-shank nails.
- b. Other code-approved fasteners may be used.
- c. For stapling asphalt shingles to Performance Category 3/8 and thicker panels, use staples with a 15/16-inch minimum crown width and a 1-inch leg length. Space according to shingle manufacturer's recommendations.
- d. See Table 6, page 17, for nail dimensions.
- e. Supported panel joints shall occur approximately along the centerline of framing with a minimum bearing of 1/2". Fasteners shall be located 3/8 inch from panel edges.
- f. For spans 48 inches or greater, space nails 6 inches at all supports.

Notes: Gluing of roof sheathing to framing is not recommended, except when recommended by the adhesive manufacturer for roof sheathing that already has been permanently protected by roofing.

The span rating in the trademark applies when the long panel dimension or strength axis is across supports unless the strength axis is otherwise identified.

APA RATED SHEATHING is equally effective under built-up roofing, asphalt or fiberglass shingles, tile roofing, or wood shingles or shakes. Roof trusses spaced 24 inches on center are widely recognized as the most economical construction for residential roofs. However, using fewer supports with thicker panels—e.g., Performance Category 23/32 panels with a span rating of 48/24 over framing 48 inches on center—is also cost effective for long-span flat or pitched roofs. Recommended live loads are given in Table 33. Nailing recommendations are given in Table 35.

When support spacing exceeds the maximum length of an unsupported edge (see Table 33), provide adequate blocking, tongue-and-groove edges or other edge support such as panel clips. Some types of panel clips, in addition to edge support, automatically assure proper panel spacing. When required, use one panel clip per span, except use two clips for 48-inch or longer spans.

See APA's *Build A Better Home: Roofs*, Form A535, for additional recommendations to prevent moisture infiltration in roofs.

Preframed Roof Panels

Preframed, or “panelized,” wood roof systems are common on warehouse and other commercial buildings in some parts of North America, due to their cost-effectiveness and speed of construction. Spans of 8 to 12 feet are usually the most practical with preframed panel construction, although spans to 30 feet are not uncommon. APA panels with stiffeners preframed at 16 or 24 inches on center (Figure 22) are common. The long dimension or strength axis of the panel typically runs parallel to supports. Stiffeners and roof purlins provide support for all panel edges. Minimum nailing requirements for preframed panels are the same as for roof sheathing.

TYPICAL SHEATHING TRADEMARKS

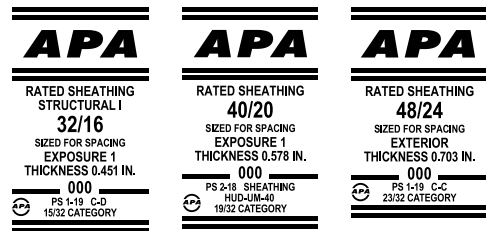

FIGURE 22

PREFRAMED ROOF PANEL (4' x 8'—APA Structural Panels Strength Axis Parallel to Supports)

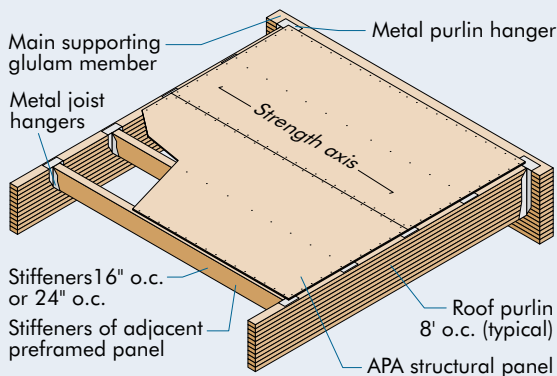
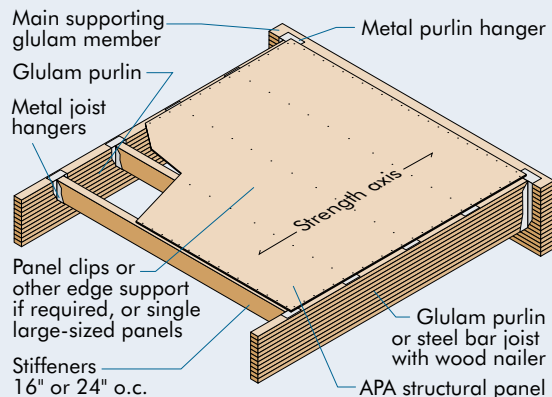

FIGURE 23

PREFRAMED ROOF PANEL (8' x 8' or larger—APA Structural Panels Strength Axis Perpendicular to Supports)



In preframed panels 8x8 feet or larger (Figure 23), the panel strength axis may run either parallel or perpendicular to stiffeners spaced 16 or 24 inches on center. Stiffeners and roof purlins provide support for all panel edges. Recommendations in Table 36 are based on long dimension or strength axis of the panel parallel to supports. Deflection limits are 1/180 of span for total load; 1/240 of span for live load only. See Table 37 for design information on stiffeners for preframed panels. Nailing requirements for preframed panels are the same as for roof sheathing.

TABLE 36

RECOMMENDED ROOF LOADS (PSF) FOR APA RATED SHEATHING WITH STRENGTH AXIS PARALLEL TO SUPPORTS^{a,b} (OSB and 5-ply/5-layer plywood panels unless otherwise noted)

| Panel Grade | Panel Performance Category | Span Rating | Maximum Span (in.) | Load at Maximum Span | |
|----------------------------------|----------------------------|-------------|--------------------|----------------------|------------------|
| | | | | Live | Total |
| APA STRUCTURAL I RATED SHEATHING | 7/16 | 24/16 | 24 ^c | 15 | 25 |
| | 15/32, 1/2 | 32/16 | 24 | 30 ^d | 40 ^d |
| | 19/32, 5/8 | 40/20 | 24 | 70 ^e | 80 ^e |
| | 23/32, 3/4 | 48/24 | 24 | 105 ^f | 115 ^f |
| APA RATED SHEATHING | 7/16 | 24/16 | 16 | 35 | 45 |
| | 15/32, 1/2 | 32/16 | 24 ^c | 15 ^g | 25 ^g |
| | 19/32, 5/8 | 40/20 | 24 | 40 ^h | 50 ^h |
| | 23/32, 3/4 | 48/24 | 24 | 70 ^e | 80 ^e |

- a. For guaranteed or warranted roofs, contact membrane manufacturer for acceptable deck.
- b. Provide edge support.
- c. Solid blocking recommended at panel ends for 24-inch span.
- d. For 4-ply plywood, reduce load by 10 psf.
- e. For 4-ply plywood, reduce load by 30 psf.
- f. For 4-ply plywood, reduce load by 45 psf.
- g. For 4-ply plywood, reduce load by 5 psf.
- h. For 4-ply plywood, reduce load by 15 psf.

TABLE 37

STIFFENER LOAD-SPAN TABLES FOR PREFRAMED APA PANEL ROOF DECKS

| Douglas-fir-Larch | | Allowable Roof Live Load (psf) ^a | | | | | | | | | | | |
|---|----------------------------------|---|------|------|-----------------------|------|------|-----------------------|------|------|-----------------------|------|------|
| Center-to-Center Purlin Spacing ^b (ft) | Stiffener Size and Spacing (in.) | Select Structural | | | No. 1 & Better | | | No. 1 | | | No. 2 | | |
| | | Strength ^d | | | Strength ^d | | | Strength ^d | | | Strength ^d | | |
| | | Defl. ^c | 1.15 | 1.25 | Defl. ^c | 1.15 | 1.25 | Defl. ^c | 1.15 | 1.25 | Defl. ^c | 1.15 | 1.25 |
| 8 | 2x4@16 | 37 | 67 | 73 | 35 | 51 | 57 | 33 | 41 | 46 | 31 | 36 | 40 |
| | 2x4@24 | 25 | 41 | 46 | 23 | 31 | 34 | 22 | 24 | 27 | 21 | 21 | 23 |
| | 2x6@16 | 144 | 154 | 168 | 136 | 121 | 133 | 129 | 99 | 109 | 121 | 88 | 97 |
| | 2x6@24 | 96 | 99 | 109 | 91 | 78 | 85 | 86 | 63 | 69 | 81 | 56 | 61 |
| | 2x6@32 | 72 | 61 | 68 | 68 | 47 | 52 | 64 | 38 | 42 | 61 | 33 | 37 |
| Southern Pine | | Allowable Roof Live Load (psf) ^a | | | | | | | | | | | |
| Center-to-Center Purlin Spacing ^b (ft) | Stiffener Size and Spacing (in.) | Select Structural | | | No. 1 Dense | | | No. 1 | | | No. 2 | | |
| | | Strength ^d | | | Strength ^d | | | Strength ^d | | | Strength ^d | | |
| | | Defl. ^c | 1.15 | 1.25 | Defl. ^c | 1.15 | 1.25 | Defl. ^c | 1.15 | 1.25 | Defl. ^c | 1.15 | 1.25 |
| 8 | 2x4@16 | 35 | 46 | 51 | 35 | 46 | 51 | 31 | 41 | 46 | 27 | 27 | 31 |
| | 2x4@24 | 23 | 27 | 31 | 23 | 27 | 31 | 21 | 24 | 27 | 18 | 15 | 17 |
| | 2x6@16 | 136 | 116 | 127 | 136 | 116 | 127 | 121 | 104 | 113 | 106 | 74 | 81 |
| | 2x6@24 | 91 | 74 | 81 | 91 | 74 | 81 | 81 | 66 | 72 | 71 | 46 | 51 |
| | 2x6@32 | 68 | 45 | 50 | 68 | 45 | 50 | 61 | 39 | 44 | 53 | 27 | 30 |

- a. Final allowable load is the lesser of the loads as determined by deflection and stress.
- b. Actual span of stiffeners taken as 3-1/2 inches less than center-to-center spacing of purlins.
- c. Deflection limitations: Span/240 under live load only; Span/180 under total load, assuming a dead load of 10 psf.
- d. Loads limited by stress are based on two conditions of duration of load: two months, such as for snow (1.15); and seven days (1.25); includes effects of 10 psf dead load.

Long Span Systems

Both preframed panel systems and direct application of sheathing to secondary or primary framing are common approaches in long span roof construction. Bay spacing and type of framing govern the choice.

Experience shows that panels over supports 48 inches on center often yield maximum economy. Panels with a span rating of 48/24 are good for at least 30 psf snow load and meet the requirements for most guaranteed or warranted roofs. Panels are assumed continuous over two spans with long dimension or strength axis across supports.

Figure 24 illustrates typical connections for engineered flat roof members.

FIGURE 24

TYPICAL CONNECTIONS TO ENGINEERED FLAT ROOF MEMBERS

Panels Nailed to Wood I-Joist

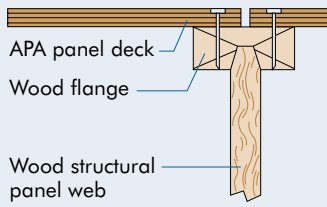

Panels Nailed to Open-Web Parallel-Chord Wood Truss

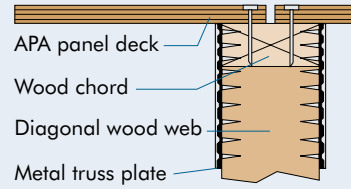

Panels Nailed to Nailer Bolted to Steel Joist

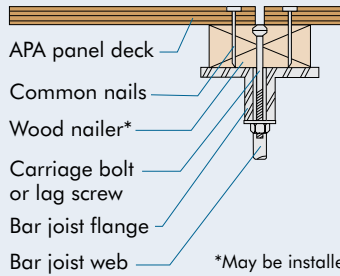

Panels Nailed to Glulam Beam

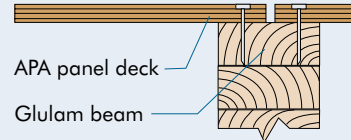

*May be installed across joists (good for nonmodular joist spacing).

APA Panel Soffits

Recommended spans for open and closed APA panel soffits are given in Tables 38 and 39. The recommendations in Table 38 for open soffits also apply to combined roof/ceiling construction. Panels are assumed continuous over two or more spans with the long dimension or strength axis across supports for both applications. For appearance purposes in open soffit construction, provide blocking, tongue-and-groove edges or other suitable edge support. Panels will support at least 30 psf live load plus 10 psf dead load.

FIGURE 25
OPEN SOFFIT

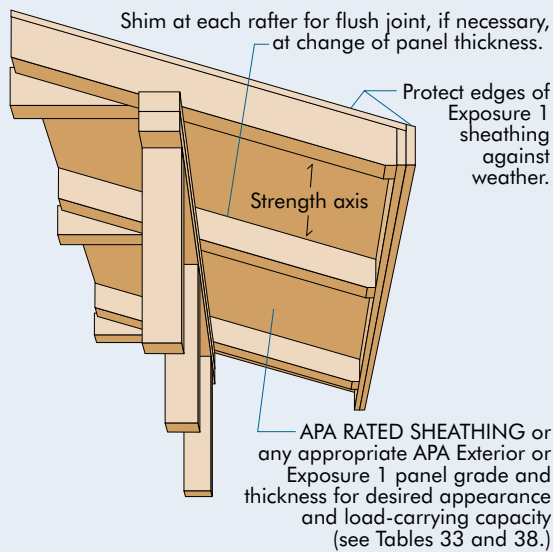

FIGURE 26
CLOSED SOFFIT

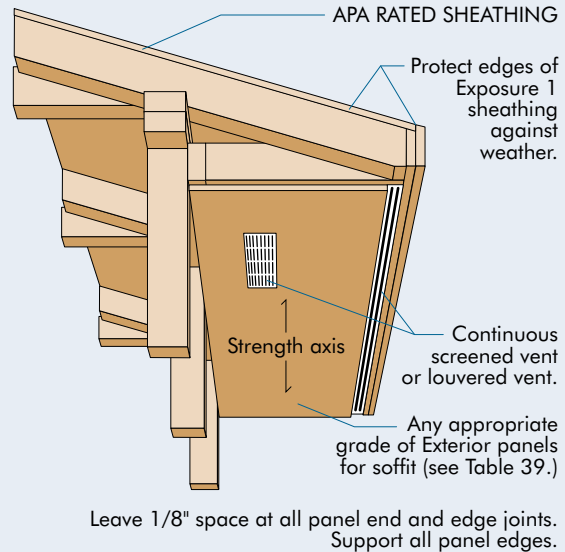

TABLE 38

APA PANELS FOR OPEN SOFFIT OR FOR COMBINED ROOF DECKING-CEILING^{a,b}
(Strength axis across supports. For APA RATED SHEATHING, where appearance is not a major concern, see Table 33.)

| Maximum Span (inches) | Panel Description (All panels Exterior or Exposure 1) | Species Group for Plywood |
|-----------------------|---|---------------------------|
| 16 | Performance Category 15/32 APA RATED SIDING 303 | 1, 2, 3, 4 |
| | Performance Category 15/32 APA MDO, Sanded and Touch-Sanded Plywood | 1, 2, 3, 4 |
| 24 | Performance Category 15/32 APA RATED SIDING 303 | 1 |
| | Performance Category 15/32 APA MDO, Sanded and Touch-Sanded Plywood | 1, 2, 3 |
| | Performance Category 19/32 APA RATED SIDING 303 | 1, 2, 3, 4 |
| | Performance Category 19/32 APA MDO, Sanded and Touch-Sanded Plywood | 1, 2, 3, 4 |
| 32 | APA RATED STURD-I-FLOOR 16 oc | — |
| | Performance Category 19/32 APA RATED SIDING 303 | 1 |
| | Performance Category 19/32 APA MDO, Sanded and Touch-Sanded Plywood | 1 |
| | Performance Category 23/32 APA Textured Plywood ^c | 1, 2, 3, 4 |
| 48 | Performance Category 23/32 APA MDO, Sanded and Touch-Sanded Plywood | 1, 2, 3, 4 |
| | APA RATED STURD-I-FLOOR 20 oc | — |
| | Performance Category 1-1/8 APA Textured Plywood ^c | 1, 2, 3, 4 |
| | APA RATED STURD-I-FLOOR 48 oc | — |

- a. All panels will support at least 30 psf live load plus 10 psf dead load at maximum span.
- b. For appearance purposes, blocking, tongue-and-groove edges or other suitable edge supports should be provided.
- c. Also see Table 33 for APA RATED SHEATHING/CEILING DECK.

TABLE 39

APA PANELS FOR CLOSED SOFFIT OR FOR NONSTRUCTURAL CEILING^{a,b} (Strength axis across supports)

| Maximum Span (in.) All Edges Supported | Panel Performance Category | Species Group | Nail Size and Type ^c |
|---|-------------------------------|--------------------------|------------------------------------|
| 24 | 11/32 ^d | All Species Groups | 6d nonstaining box or casing |
| 32 | 15/32 ^d | | |
| 48 | 19/32 ^d | | 8d nonstaining box or casing |

a. Space nails maximum 6 inches at panel edges and 12 inches at intermediate supports for spans less than 48 inches; 6 inches at all supports for 48-inch spans.

b. For appearance purposes, blocking, tongue-and-groove edges or other suitable edge supports should be provided.

c. See Table 6, page 17, for nail dimensions.

d. Any suitable grade panel which meets appearance requirements—Exterior for closed soffits, Exposure 1 or Exterior for nonstructural ceiling.

For open soffit and nonstructural ceiling construction, panels designated Exposure 1 are recommended as a minimum (check local building code) where appearance is not a major consideration.

Only Exterior panels should be used for closed soffits.

At eaves where Exposure 1 sheathing is used for roof decking, protect panel edges against direct exposure to the weather with fascia trim.

Although unsanded and touch-sanded grades of plywood are often used for applications such as soffits, optimum appearance and finish performance is attained by using panels with textured or sanded A-grade faces. For panel grades other than APA RATED SIDING 303, top-quality acrylic latex house paint systems provide best performance (see page 75). Face-checking (separations between fibers parallel to the grain of the face veneer) can be expected on non-overlaid plywood which is exposed to the outdoors, even when finished. If a smooth, check-free surface is desired, use Medium Density Overlay (MDO) plywood.

APA Panel Roof Diaphragms

With only slight design modifications, any APA panel roof deck system described in the previous sections will also function as an engineered diaphragm to resist high wind and seismic loading. A diaphragm's ability to function effectively as a beam, transferring lateral loads to shear walls, is related to the quality of the connections. Nailing is critical since shear loads are transmitted through these fasteners. Common nails provide required strength. Other nail types may be used when their lateral bearing values are considered in the design. Load-carrying capacity is highest when the diaphragm is blocked.

Where Performance Category 1-1/8 roof panels are desired, such as for Heavy Timber construction (see page 93), shear values for Performance Category 19/32 panels are used. Blocked shear values for Performance Category 1-1/8 panels may be obtained by specifying stapled tongue-and-groove edges. Staples shall be 16 gauge, 1-inch long with a 3/8-inch crown, driven through the tongue-and-groove edges 3/8 inch from the joint so as to penetrate the tongue with both legs of the staple. Staples shall be spaced at one-half of the diaphragm boundary nail spacing for Cases 1 and 2, and at one-third the diaphragm boundary nail spacing for Case 3 through 6, as illustrated in Table 40.

TABLE 40

ALLOWABLE SHEAR (POUNDS PER FOOT) FOR HORIZONTAL APA PANEL DIAPHRAGMS WITH FRAMING OF DOUGLAS-FIR, LARCH OR SOUTHERN PINE^a FOR WIND^{b,c} OR SEISMIC LOADING^c

| Panel Grade | Common Nail Size ^f | Minimum Nail Penetration in Framing (in.) | Minimum Nominal Panel Thickness (in.) | Minimum Nominal Width of Framing Members at Adjoining Panel Edges and Boundaries ^g (in.) | Blocked Diaphragms | | | | Unblocked Diaphragms | |
|---|-------------------------------|---|---------------------------------------|---|---|-----|--------------------|----------------|---|---|
| | | | | | Nail Spacing (in.) at diaphragm boundaries (all cases), at continuous panel edges parallel to load (Cases 3 & 4), and at all panel edges (Cases 5 & 6) ^d | | | | Nails Spaced 6" max. at Supported Edges ^d | |
| | | | | | 6 | 4 | 2-1/2 ^e | 2 ^e | Case 1 (No unblocked edges or continuous joints parallel to load) | All other configurations (Cases 2, 3, 4, 5 & 6) |
| APA STRUCTURAL I grades | 6d ^h | 1-1/4 | 5/16 | 2 | 185 | 250 | 375 | 420 | 165 | 125 |
| | | | | 3 | 210 | 280 | 420 | 475 | 185 | 140 |
| | 8d | 1-3/8 | 3/8 | 2 | 270 | 360 | 530 | 600 | 240 | 180 |
| | | | | 3 | 300 | 400 | 600 | 675 | 265 | 200 |
| 10d ⁱ | 1-1/2 | 15/32 | 2 | 320 | 425 | 640 | 730 | 285 | 215 | |
| | | | 3 | 360 | 480 | 720 | 820 | 320 | 240 | |
| APA RATED SHEATHING APA RATED STURD-I-FLOOR and other APA grades except Species Group 5 | 6d ^h | 1-1/4 | 5/16 | 2 | 170 | 225 | 335 | 380 | 150 | 110 |
| | | | | 3 | 190 | 250 | 380 | 430 | 170 | 125 |
| | | | 3/8 | 2 | 185 | 250 | 375 | 420 | 165 | 125 |
| | | | | 3 | 210 | 280 | 420 | 475 | 185 | 140 |
| | | | 3/8 | 2 | 240 | 320 | 480 | 545 | 215 | 160 |
| | | | | 3 | 270 | 360 | 540 | 610 | 240 | 180 |
| | 8d | 1-3/8 | 7/16 | 2 | 255 | 340 | 505 | 575 | 230 | 170 |
| | | | | 3 | 285 | 380 | 570 | 645 | 255 | 190 |
| | | | 15/32 | 2 | 270 | 360 | 530 | 600 | 240 | 180 |
| | | | | 3 | 300 | 400 | 600 | 675 | 265 | 200 |
| | | | 15/32 | 2 | 290 | 385 | 575 | 655 | 255 | 190 |
| | | | | 3 | 325 | 430 | 650 | 735 | 290 | 215 |
| 10d ⁱ | 1-1/2 | 19/32 | 2 | 320 | 425 | 640 | 730 | 285 | 215 | |
| | | | 3 | 360 | 480 | 720 | 820 | 320 | 240 | |

- a. For framing of other species: (1) Find specific gravity for species of lumber in the AWC *National Design Specification* (NDS). (2) Find shear value from table above for nail size for actual grade. (3) Multiply value by the following adjustment factor: Specific Gravity Adjustment Factor = [1 - (0.5 - SG)], where SG = specific gravity of the framing. This adjustment shall not be greater than 1.
- b. For wind load applications, the values in the table above shall be permitted to be multiplied by 1.4.
- c. For shear loads of normal or permanent load duration as defined by the NDS, the values in the table above shall be multiplied by 0.63 or 0.56, respectively.
- d. Space nails maximum 12 inches o.c. along intermediate framing members (6 inches o.c. when supports are spaced 48 inches o.c. or greater). Fasteners shall be located 3/8" from panel edges.
- e. Framing at adjoining panel edges shall be 3" nominal or wider, and nails shall be staggered where nails are spaced 2 inches o.c. or 2-1/2 inches o.c.
- f. See Table 6, page 17, for nail dimensions.
- g. The minimum normal width of framing members not located at boundaries or adjoining panel edges shall be 2".
- h. 8d is recommended minimum for roofs due to negative pressures of high winds.
- i. Framing at adjoining panel edges shall be 3" nominal or wider, and nails shall be staggered where 10d nails having penetration into framing of more than 1-1/2" are spaced 3 inches o.c.

Continued on next page

TABLE 40 (Continued)

ALLOWABLE SHEAR (POUNDS PER FOOT) FOR HORIZONTAL APA PANEL DIAPHRAGMS WITH FRAMING OF DOUGLAS-FIR, LARCH OR SOUTHERN PINE^a FOR WIND^{b,c} OR SEISMIC LOADING^c

Note: Design for diaphragm stresses depends on direction of continuous panel joints with reference to load, not on direction of long dimension or strength axis of sheet. Continuous framing may be in either direction for blocked diaphragms.

Long Panel Direction Perpendicular to Supports**Long Panel Direction Parallel to Supports**

Table 40 gives panel and fastening recommendations for roof diaphragms. Panels and framing are assumed already designed for perpendicular loads. To design a diaphragm, follow these steps:

1. Determine lateral loads and resulting shears.
2. Determine nailing schedule (Table 40). Consider load direction with respect to joints.
3. Compute chord stress due to bending moment. Provide adequate splices. Check deflection. Check anchorage of boundary framing (e.g., chords) to walls.

For information about developing higher diaphragm shears than shown in Table 40, see *APA Design/Construction Guide: Diaphragms and Shear Walls*, Form L350.

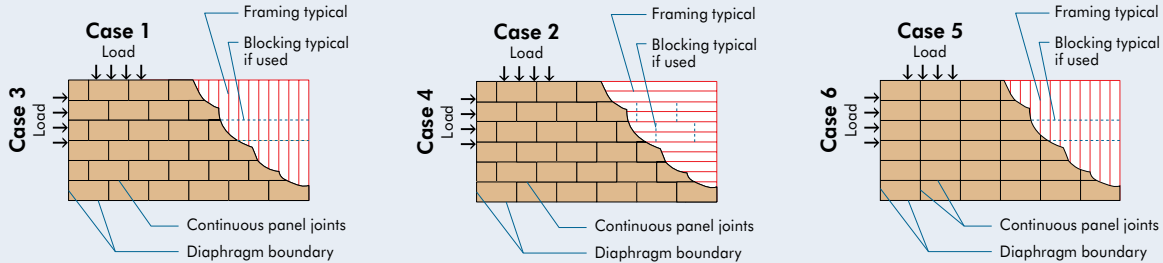
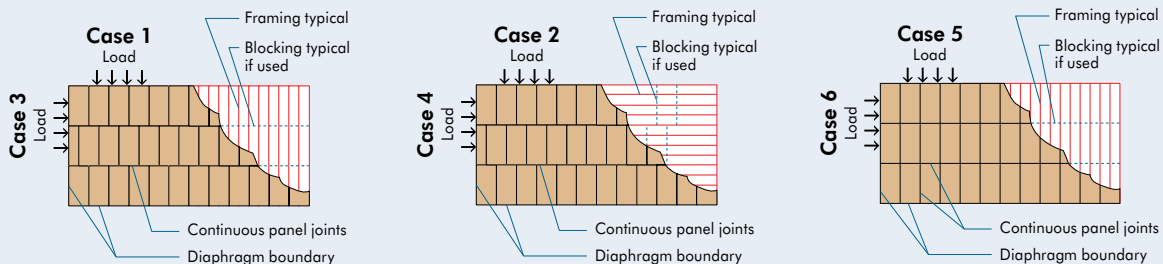

ADDITIONAL FIRE AND BUILDING SYSTEMS

FIRE SYSTEMS

Fire Protection of Residential Floors

Starting with the 2009 IBC and IRC, one- and two-family dwellings are required to be sprinklered (IBC 903.2.8 and IRC R313.1). However, not all local jurisdictions in the U.S. have adopted these provisions for the use of sprinkler systems as an active home fire protection system. In May 2010, the International Code Council (ICC) added the following new residential floor fire protective membrane provisions to the IRC; refer to 2018 IRC Section R302.13.

R302.13 Fire protection of floors. *Floor assemblies that are not required elsewhere in this code to be fire-resistance rated, shall be provided with a 1/2-inch gypsum wallboard membrane, 5/8-inch wood structural panel membrane, or equivalent on the underside of the floor framing member. Penetrations or openings for ducts, vents, electrical outlets, lighting, devices, luminaires, wires, speakers, drainage, piping and similar openings or penetrations shall be permitted.*

Exceptions:

1. Floor assemblies located directly over a space protected by an automatic sprinkler system in accordance with Section P2904, NFPA 13D, or other approved equivalent sprinkler system.
2. Floor assemblies located directly over a crawl space not intended for storage or for the installation of fuel-fired or electric-powered heating appliances.
3. Portions of floor assemblies shall be permitted to be unprotected where complying with the following:
 - 3.1 The aggregate area of the unprotected portions does not exceed 80 square feet per story.
 - 3.2 Fireblocking in accordance with Section R302.11.1 is installed along the perimeter of the unprotected portion to separate the unprotected portion from the remainder of the floor assembly.
4. Wood floor assemblies using dimension lumber or structural composite lumber equal to or greater than 2-inch by 10-inch nominal dimension, or other approved floor assemblies demonstrating equivalent fire performance.

It should be noted that these fire protective membrane provisions apply to not only I-joist floors, but all residential floor assemblies, including floor trusses, light-gauge steel framing and dimension lumber and structural composite lumber less than 2-inch by 10-inch nominal dimension. They will become effective when adopted by the local jurisdiction. The project designer shall consult with the local jurisdiction for code requirements.

In addition to the IRC-prescribed 1/2-inch gypsum or 5/8 wood structural panel protection, *APA System Report SR-405, Fire Protection of Floors Constructed with Prefabricated Wood I-Joists for Compliance with the International Residential Code* provides prescriptive protective methods for engineered wood I-joists that have demonstrated equivalency to Exception 4 of the 2018 IRC Section R302.13 in accordance with ICC-ES AC14 requirements.

One such system uses gypsum board set on top of the bottom flanges of the I-joists to provide code-compliant fire protection. It is easy to install, does not require fasteners or adhesives and is easy to temporarily remove to access mechanical systems.

One variation of this method uses 1/2-inch gypsum board installed on top of the bottom flange for joists spaced 19.2 inches or less on center. The second option, pictured in Figure 27, calls for 5/8-inch gypsum board where joists are spaced up to 24 inches on center.

These and additional assemblies that meet IRC fire-protective requirements are detailed in *APA System Report SR-405*, available for free download from the APA website, www.apawood.org.

FIGURE 27

5/8-INCH GYPSUM BOARD

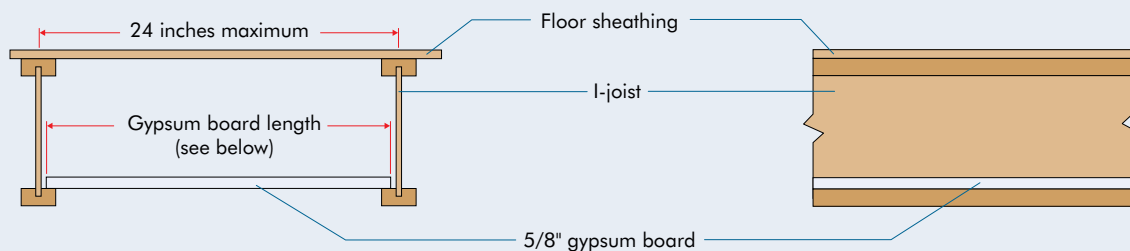

| Joist spacing (in.) | Required length for gypsum boards (in.) |
|---------------------|---|
| 12 | 11-1/8 ± 1/8 |
| 16 | 15-1/8 ± 1/8 |
| 19.2 | 18-3/8 ± 1/8 |
| 24 | 23-1/8 ± 1/8 |

Note:
Gypsum board lengths shown above provide at least a 1/4-inch bearing on the top of the bottom flange in each I-joist as installed. For other joist spacings, the required gypsum board lengths shall be adjusted so that the required gypsum board lengths are determined based on a full bearing on the flange at one end of the joist spacing, while maintaining at least a 1/4-inch bearing at the other end. If double joists are used, the required gypsum board lengths shall be reduced from the table above by a length equal to the flange width.

Protected Floor/Ceiling Construction

Protected construction includes typical floor-ceiling, roof-ceiling or wall assemblies with wood structural panels fastened to wood or steel framing, and a fire-resistive material, such as gypsum wallboard, plaster or mineral acoustical tile, added to give primary protection to framing. The structural panels slow flame passage and temperature rise while reinforcing supports against collapse under load.

Assemblies are rated in fire tests by Underwriters Laboratories (U.L.) and other agencies. Over 40 floor-ceiling (and/or roof-ceiling) systems using wood structural panels are described in the U.L. *Fire Resistance Directory*. They are accepted as rated constructions by most building codes. Examples of one-hour-rated floor-ceiling assemblies are shown in Figures 28 and 29; several two-hour-rated wood-framed assemblies also are described in the U.L. *Directory*. For additional information, see *APA Design/Construction Guide: Fire-Rated Systems*, Form W305.

In many fire-resistant floor-ceiling assemblies, a two-layer floor system (Performance Category 15/32 subfloor and Performance Category 19/32 underlayment) is used, although several have single-layer Performance Category 5/8 or larger combination subfloor-underlayment panels. Any finish floor material may be used. The International Building Code permits omission of the top panel layer in roof assemblies or where unusable space occurs above (2018 IBC Table 721.1(3)).

For more information on using APA Rim Boards® in fire-resistant construction, consult *APA Data File: APA Rim Board in Fire Rated Assemblies*, Form D350, which provides recommendations for the use of APA Rim Board in conjunction with fire-rated wall and/or floor assemblies, or *APA Technical Topic TT-124: Uniform Vertical Load Capacity of Glulam Rim Boards Subject to Fire Exposure*.

FIGURE 28

ONE-HOUR COMBUSTIBLE FLOOR-CEILING AND ROOF-CEILING ASSEMBLIES—LUMBER JOISTS

Some rated assemblies incorporate proprietary products. When designing and specifying, check the Underwriters Laboratories Inc. (U.L.) *Fire Resistance Directory* for complete details on a particular assembly. A change in details may affect the fire resistance of the assembly.

28A TWO-LAYER FLOOR SYSTEM WITH LUMBER JOISTS^{a,b}

For details, see U.L. Design Nos. L006, L201, L202, L206, L209, L210, L211 (2 hr), L212, L501, L502, L503, L505 (2 hr), L507, L511 (2 hr), L512, L513, L514, L515, L516, L517, L519, L522, L523, L525, L526, L532(1-1/2 hr), L533, L535, L536 (2 hr), L537, L539, L540, L541 (2 hr), L545 and L569. Also see U.L. Design Nos. L524 with steel joists spaced 24" o.c., L521, L528, L529 and L534 with wood trusses spaced 24" o.c., L549 with steel trusses spaced 48" o.c. and L527 with steel joists spaced 24" o.c.

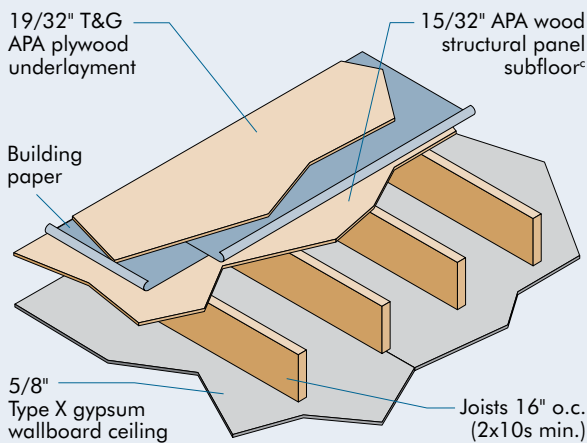

28B SINGLE-LAYER FLOOR SYSTEM WITH LUMBER JOISTS

For details, see U.L. Design No. L513. Also see U.L. Design Nos. L504 for stressed-skin panel (5/8" APA RATED STURD-I-FLOOR or SHEATHING plywood with joists spaced 12" o.c.), L507 for 5/8 CAT APA RATED STURD-I-FLOOR plywood with joists spaced 16" o.c., L508 for 1-1/8 CAT APA RATED STURD-I-FLOOR plywood with joists spaced 48" o.c. and L539, L540 with joists spaced 16" or 24" o.c. and separate ceiling assembly (for modular housing units). Also see U.L. Design Nos. L524 and L543 with steel joists spaced 19.2" or 24" o.c. (L543 with separate ceiling assembly).

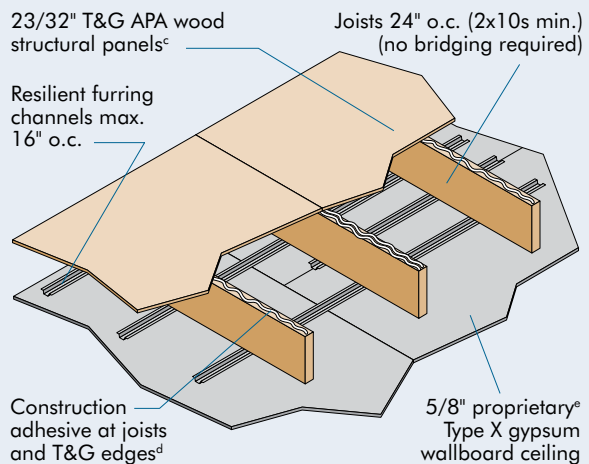

- Substitution of 1-1/8" APA RATED STURD-I-FLOOR 48 oc for the combination of subfloor, paper and underlayment is often allowed. Check with local building official.
- Most building codes do not require the top layer of two-layer rated assemblies when used for roofs.
- Tests have shown that substitution of OSB or composite APA RATED SHEATHING subfloor and APA RATED STURD-I-FLOOR underlayment for the plywood panels in rated assemblies will not jeopardize fire-resistance ratings. Substitution is based on equivalent panel thickness, except that in two-layer wood assemblies, 7/16" OSB subfloor panels may be used in place of 15/32" plywood subfloor panels.
- Construction adhesive to conform to APA Specification AFG-01 or ASTM D3498.
- For proprietary names, see latest U.L. *Fire Resistance Directory*.

FIGURE 29

ONE-HOUR COMBUSTIBLE FLOOR-CEILING AND ROOF-CEILING ASSEMBLIES—I-JOISTS

29A—ONE-HOUR FIRE-RESISTIVE FLOOR/CEILING ASSEMBLY

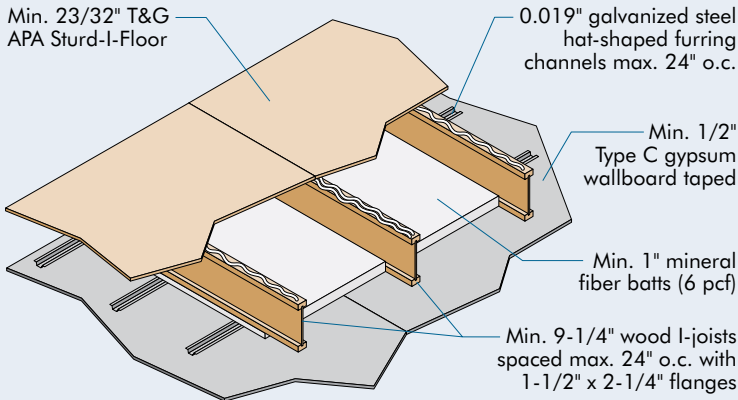

For additional details, see AWC DCA 3, Assembly WIJ-1.4 (www.awc.org)

STC AND IIC SOUND RATINGS

| Without Gypsum Concrete | | | |
|-------------------------|-----|----------------|-----|
| Cushioned Vinyl | | Carpet and Pad | |
| STC | IIC | STC | IIC |
| - | - | 46 | 68 |
| With Gypsum Concrete | | | |
| Cushioned Vinyl | | Carpet and Pad | |
| STC | IIC | STC | IIC |
| 51 | 47 | 50 | 73 |

29B—ONE-HOUR FIRE-RESISTIVE FLOOR/CEILING ASSEMBLY^a

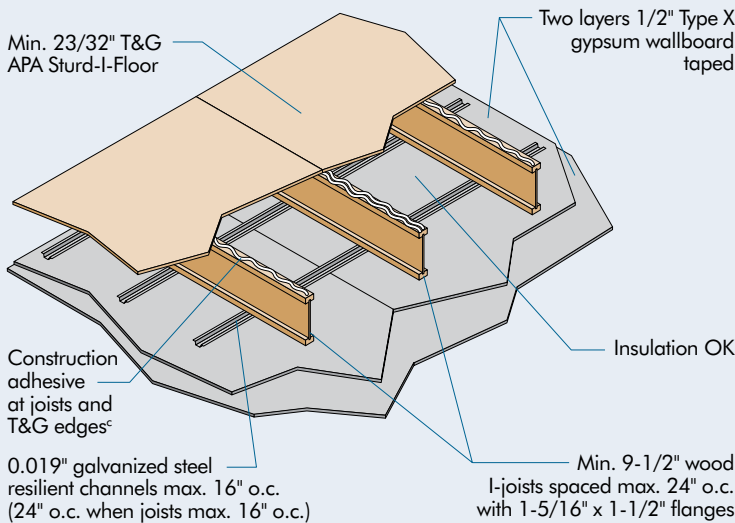

For additional details, see AWC DCA 3, Assembly WIJ-1.6 (www.awc.org) or 2018 IBC Table 721.1(3) Item 27-1.1.

STC AND IIC SOUND RATINGS

| Without Gypsum Concrete | | | |
|-------------------------|-----|-----------------|-----------------|
| Cushioned Vinyl | | Carpet and Pad | |
| STC | IIC | STC | IIC |
| - | - | 54 | 68 |
| With Gypsum Concrete | | | |
| Cushioned Vinyl | | Carpet and Pad | |
| STC | IIC | STC | IIC |
| - | - | 58 ^b | 55 ^b |

For other plywood floor-ceiling assemblies, see U.L. Design Nos. L506 (3/4 hr), L509 (1/2 hr), L520 (3/4 hr).

The following fire-rated floor-ceiling or roof-ceiling assemblies include thermal or acoustical insulation in the joist cavity:

| U.L. Design No. | Insulation | Thickness (in.) | U.L. Design No. | Insulation | Thickness (in.) |
|-----------------|-------------------------|-----------------|-----------------|-----------------------------------|-----------------|
| L211 (2 hr) | Glass fiber batts | 6 | L539 | Glass fiber batts | 3-5/8 |
| L212 | Glass fiber batts | 6 | L540 | Glass fiber batts | 3-5/8 |
| L507 | Mineral wool (blown in) | 3.5 PCF | L541 (2 hr) | Mineral wool batts | 3 |
| L516 | Glass fiber batts | 3 | L543 | Mineral wool (blown in) | 3-1/2 |
| L520 (3/4 hr) | Glass fiber batts | 3 | L545 | Glass fiber batts | 3 |
| L521 | Glass fiber batts | 3-1/2 | L549 | Glass fiber or mineral wool batts | Any |
| L532 (1-1/2 hr) | Glass fiber batts | 3-1/2 | L569 | Glass fiber or mineral wool batts | 3-1/2 |
| L533 | Glass fiber batts | 3 | | | |

a. This assembly may also be used in a fire-rated roof/ceiling application, but only when constructed exactly as described.

b. STC and IIC values estimated by David L. Adams Associates, Inc.

c. Construction adhesive to conform to ASTM D3498 or APA Specification AFG-01.

Sprinkler System Installation for I-Joists

Wood I-joists are often used in conjunction with fire suppression sprinkler systems. Most wood I-joist design tables are based on an assumed uniform load. Joists and other supporting systems must be designed to carry the added weight of the sprinkler system. This may necessitate the use of deeper I-joists, joists with shorter spans, closer spacing and/or a different I-joist series with higher moment and stiffness capacities.

Refer to *APA Technical Note: Sprinkler System Installation for APA Performance Rated I-Joists*, Form J745, for detailed sprinkler system design and installation information.

For additional information on installing and designing with I-joists, including information on allowable spans, installation details, architectural specifications and engineering design properties, refer to *APA Performance Rated I-Joists*, Form Z725, and *I-Joist Construction Details—Performance Rated I-Joist Roof Framing Details*, Form D710.

Protected Wall Construction

Plywood siding or wall sheathing in combination with gypsum sheathing and wallboard on studs is recognized by code officials for one-hour load-bearing exterior walls. A typical example—APA RATED SIDING over 5/8-inch Type X gypsum sheathing attached to 2x studs 16 or 24 inches on center—is illustrated in Figure 30. Under the 2018 IBC, Section 705.5, the fire-resistive rating for exterior walls applies only to the inside of the wall when separation to the property line is greater than 10 feet. In this common situation, the gypsum sheathing can be omitted under the siding as noted in Figure 30.

FIGURE 30

ONE-HOUR FIRE-RATED EXTERIOR LOAD-BEARING WALL ASSEMBLY^a

Min. 2x4 studs at 16" or 24" o.c.

Mineral wool or glass fiber insulation (optional)

5/8" Type X gypsum wallboard

5/8" Type X gypsum sheathing^b

Building paper or other code-approved weather-resistive barrier

- a. Generic, non-proprietary assembly based on GA File No. WP8105 listed in Gypsum Association *Fire Resistance Design Manual*, referenced in the model building codes. Mineral or glass fiber batt insulation (optional).
- b. Exterior layer of gypsum sheathing not required under the International Building Code, when separation is greater than 10 feet. Check local provisions. Also see U.L. Design Nos. U344 and U356 in U.L. *Fire Resistance Directory*.

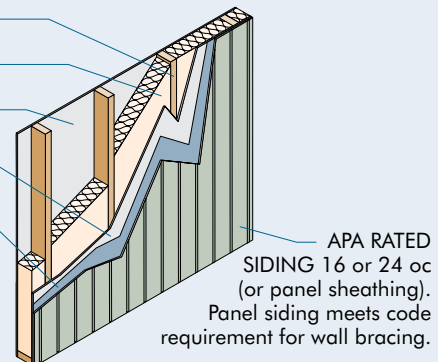

Fire-rated protected wall assemblies will qualify for the one-hour rating if other materials are added over the fire-resistive materials. For example, APA RATED SIDING panels or lap siding may be attached to the outside of a rated wall without impairing the rating. APA RATED SHEATHING is also permitted between the fire protection and wood studs (Table 721.1(2) of the 2018 IBC). For additional information, see *APA Design/Construction Guide: Fire-Rated Systems*, Form W305, and *APA Technical Topic: Load-Bearing Fire-Rated Wall Assemblies with OSB and Plywood Wall Sheathing*, Form TT-063.

Fire-Rated Roof Coverings

The fire resistance ratings of roofing materials are listed as Class A, B or C in descending order of fire protection afforded. Their use is prescribed by building codes and also affects insurance rates. Untreated APA RATED SHEATHING panels are recognized as a structural roof deck substrate for rated roof coverings. For individual requirements, see the U.L. *Roofing Materials and Systems Directory*.

Fire-Rated Structural Glued Laminated Timber

A structural member’s fire resistance is measured by the time it can support its design load during a fire. An exposed beam or column sized for a minimum one-hour fire resistance will support its full design load for at least one hour during standard ASTM E119 fire test conditions, which simulate an actual fire.

Glulam beams and columns can be adapted to a one-hour fire rating in accordance with design procedures set forth in the NDS, Chapter 16, which are recognized by the IBC. Glulam beams and columns must be of sufficient size and capacity to carry the applied loads in compliance with NDS Chapter 16 design provisions.

Beams. To adapt glulam beams for one-hour fire rating, the basic layout is modified as shown in Figure 31. One core lamination from the interior of the beam is replaced by an additional tension lamination.

Columns. Columns generally need no special layout to qualify for a one-hour fire rating but may require a larger section.

As with all structural framing, final specifications of members designed to have one-hour fire resistance should be carefully checked by a professional engineer or architect to assure compliance with all local building codes.

The use of pressure-impregnated fire retardants is not recommended for glulam.

Metal Connectors. In structures using one-hour rated glulams, supporting metal connectors and fasteners also must be designed to achieve a one-hour fire rating. Fire-rated (Type X) gypsum wallboard, a 1-1/2-inch covering of wood or any coating approved for a one-hour rating provides the needed protection.

Wall and Ceiling Paneling

The flame spread classification of materials used for interior wall and ceiling finish (and occasionally for other applications) is usually limited by building codes for certain occupancies. Tests have shown that untreated APA wood structural panels will develop flame spread index and smoke index values of 200 or less, which puts them in a Class C (or III) category.

Panels are therefore suitable as interior finish for most applications. Certain more restrictive locations, such as exitways, require a Class A or Class B rating, which can be achieved by the use of fire-retardant-treated plywood.

FIGURE 31

TYPICAL UNBALANCED GLULAM BEAM LAYUPS FOR UNRATED AND ONE-HOUR FIRE-RATED GLULAM
One extra tension lamination added for one-hour resistance.

| | |
|-------------------|---------------------|
| Outer Compression | Outer Compression |
| Inner Comp. | Inner Comp. |
| Inner Comp. | Inner Comp. |
| Core | Core |
| Core | Core |
| Core | Core |
| Core | Core |
| Core | Core |
| Core | Core |
| Core | Inner Tension |
| Inner Tension | Inner Tension |
| Inner Tension | Extra Outer Tension |
| Outer Tension | Outer Tension |
| Unrated | One Hour |

BUILDING SYSTEMS

Heavy Timber Construction

Model building codes also recognize Heavy Timber wood construction systems, which can simplify roof or floor construction while providing superior fire resistance. Heavy Timber construction does not constitute one-hour fire resistance, however.

Under fire conditions, large size timber members develop a surface char layer, which acts as insulation to slow the burning process. In addition, Heavy Timber construction does not permit concealed wall or ceiling spaces where fire can spread. Years of fire service experience shows that the structural performance of Heavy Timber construction systems under fire conditions is markedly superior to most unprotected “noncombustible” (steel) structures.

See Table 41 for minimum structural member sizes required by model building codes for Heavy Timber construction. Structural glued laminated timber (glulam), SCL and CLT also qualify for Heavy Timber construction systems when members conform to required sizes.

Insurance rating bureaus and model building codes accept Performance Category 1-1/8 tongue-and-groove wood structural panels (Exposure 1) as an alternative to 2-inch nominal tongue-and-groove lumber decking in Heavy Timber roof construction.

Typical construction (Figure 32) consists of tongue-and-groove APA RATED STURD-I-FLOOR 48 oc Exposure 1 (or Performance Category 1-1/8 tongue-and-groove APA RATED SHEATHING Exposure 1—Check local availability before specifying). Heavy Timber beams must be 4x6 minimum and are normally spaced 48 inches on center. For an exposed ceiling with improved appearance, Performance Category 1-1/8 textured siding^a or APA RATED SHEATHING/CEILING DECK panels can be specified.

Heavy Timber floors may also be constructed with Performance Category 15/32 wood structural panels over 3-inch planks.

For additional information on fire-resistant construction, see *APA Design/Construction Guide: Fire-Rated Systems*, Form W305.

a. Depending on siding thickness and support spacing, an additional layer of APA Rated Sheathing may be necessary.

TABLE 41

DIMENSIONS OF COMPONENTS FOR HEAVY TIMBER CONSTRUCTION (TYPICAL CODE PROVISIONS)

Heavy Timber construction is generally defined in building codes and standards by the following minimum sizes for the various members or portions of a building:

| | Inches, nominal |
|--|--------------------------------------|
| Columns—supporting floor loads | |
| Supporting roof and ceiling loads only..... | 8 x 8 |
| Supporting roof and ceiling loads only..... | 6 x 8 |
| Floor framing | |
| Beams and girders..... | 6 wide x 10 deep |
| Arches and trusses..... | 8 in any dimension |
| Roof framing—not supporting floor loads | |
| Arches springing from grade | 6 x 8 lower half 6 x 6 upper half |
| Arches, trusses, other framing springing from top of walls, etc. | 4 x 6 |
| Floor (covered with 1-inch nominal flooring, Performance Category 15/32 or 1/2 wood structural panels, or other approved surfacing) | |
| Spliced or tongue-and-groove plank | 3 |
| Planks set on edge..... | 4 |
| Cross-laminated timber floors | |
| Cross-laminated timber | 4 (actual thickness) |
| Roof decks | |
| Spliced or tongue-and-groove plank | 2 |
| Plank set on edge | 3 |
| Tongue-and-groove wood structural panels | Performance Category 1-1/8 |
| Cross-laminated timber roof | |
| Cross-laminated timber | 3 (nominal thickness) |

FIGURE 32

HEAVY TIMBER CONSTRUCTION

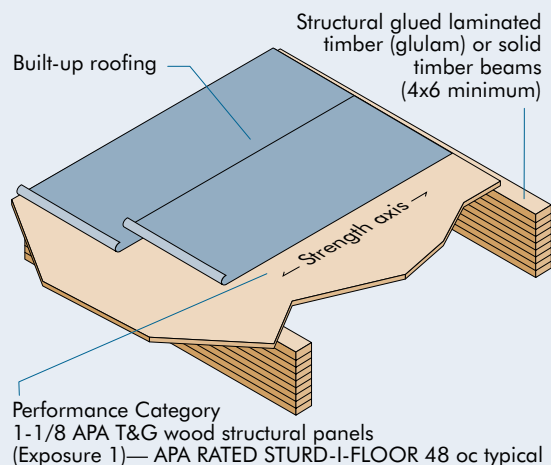

Wind-Resistive Roofs

Wind ratings are based on a roof system's performance in wind uplift tests. Systems meeting the requirements of these tests are assigned ratings that indicate how much pressure, in pounds per square foot, they successfully resisted in the test. Four Factory Mutual (FM) wind-rated assemblies are illustrated in Figures 33, 34, 35 and 36.

Other roof systems with proprietary metal roofing panels using plywood or OSB panels as a roofing substrate over steel decking or as structural roof sheathing also meet U.L. Class 90 requirements. See Figure 37. For additional information, including minimum structural panel requirements, fasteners and support spacing, see *APA Design/Construction Guide: Wind-Rated Roofs*, Form G310, and U.L. *Roof Materials and Systems Directory*.

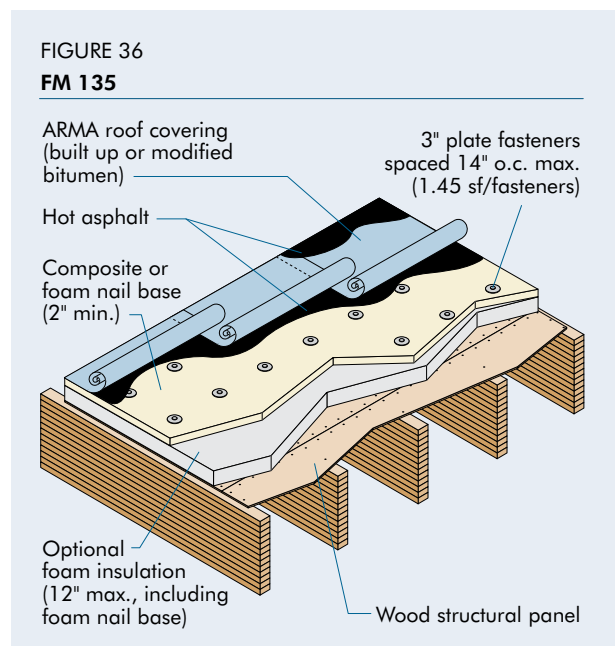
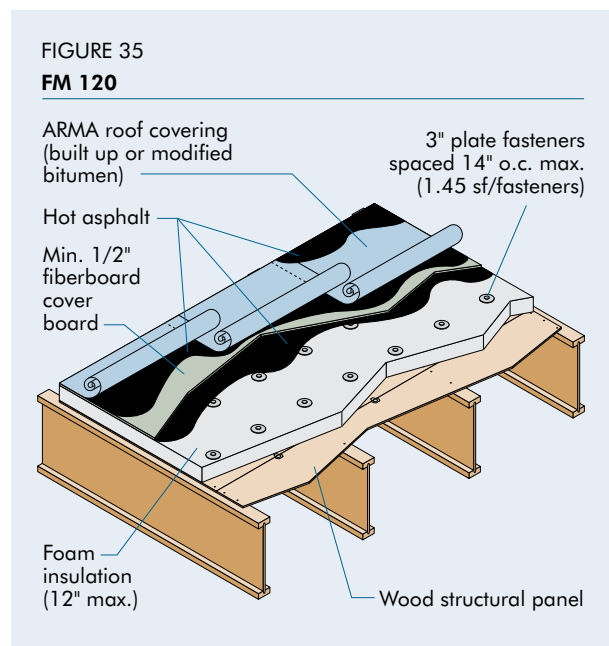
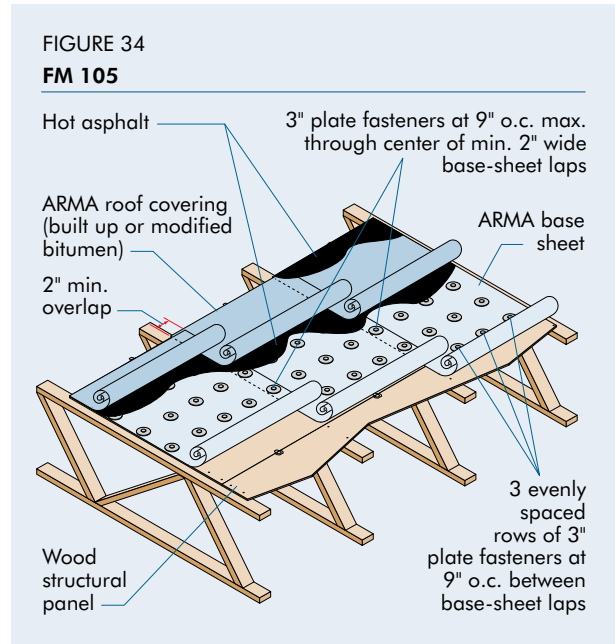
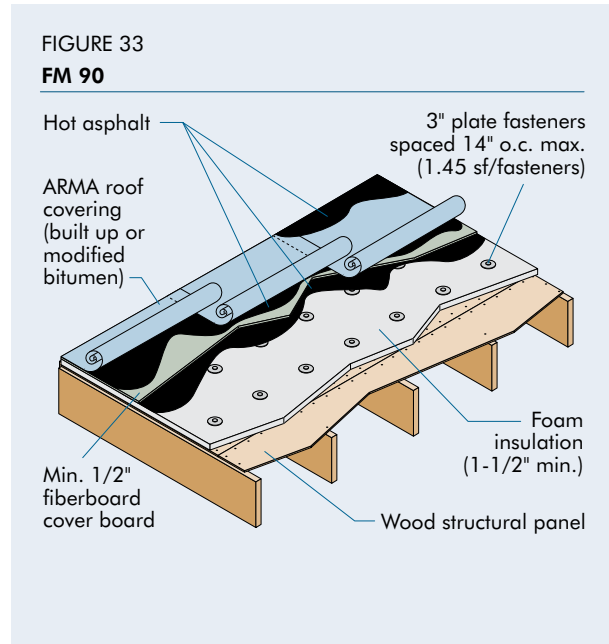

FIGURE 37

METAL ROOFING PANELS — UL CLASS 90^a

No. 15 asphalt felt vapor retarder—one or two layers (may be optional.)

APA RATED SHEATHING
plywood per PS 1 (15/32 PERF CAT or greater for framing spaced 16" o.c.; 19/32 PERF CAT or greater for framing spaced 24" o.c.)

a. Some rated assemblies and constructions incorporate OSB sheathing and proprietary products. When designing and specifying, check the Underwriters Laboratories (U.L.) *Roofing Materials and Systems Directory* (Category TGKX) for complete details on a particular assembly in U.L. Construction Nos. 200-500 (series). A change in details may affect the wind uplift classification of the assembly.

b. See Table 6, page 17, for nail diameter.

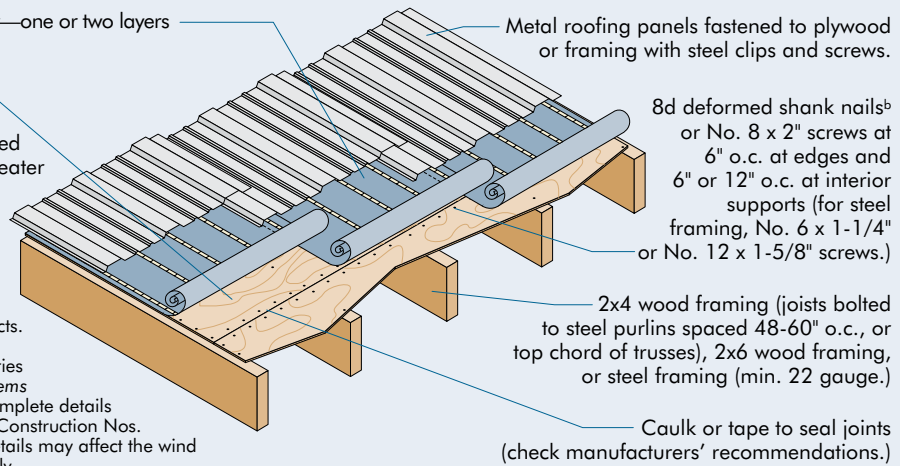

Metal roofing panels fastened to plywood or framing with steel clips and screws.

8d deformed shank nails^b or No. 8 x 2" screws at 6" o.c. at edges and 6" or 12" o.c. at interior supports (for steel framing, No. 6 x 1-1/4" or No. 12 x 1-5/8" screws.)

2x4 wood framing (joists bolted to steel purlins spaced 48-60" o.c., or top chord of trusses), 2x6 wood framing, or steel framing (min. 22 gauge.)

Caulk or tape to seal joints (check manufacturers' recommendations.)

Noise Transmission Control

While some attention to sound control may be desirable in certain types of single-family residential buildings, it is mandatory in multifamily, commercial and industrial construction.

Selection of the correct noise-resistant surface and insulation assemblies is based on Sound Transmission Class (STC) and Impact Insulation Class (IIC). See Section 1206, Sound Transmission, of the 2018 IBC. The STC rates a structural assembly's ability to reduce airborne noise. The IIC rates the ability of the structure's floor-ceiling assembly to reduce structure-borne sound. A minimum STC of 50 (or 45 if field tested) is required for floor-ceiling and wall assemblies in multi-unit dwellings. In addition, a minimum IIC of 50 (or 45 if field tested) is required in floor-ceiling assemblies. For other requirements, see Section 1206 of the 2018 IBC. Below 40, loud speech can be audible as a murmur and privacy and comfort are impaired. The level of background noise affects the choice of STC.

The IIC ratings define the capacity to control impact noise. Required IIC rating values vary considerably with the choice of finished flooring.

Figures 38 and 39 show only two of the many sound-resistant floor and wall assemblies that can be obtained with wood structural panels. Some floor-ceiling assemblies also qualify as fire-rated construction.

While many listed assemblies were tested using plywood, other APA OSB panels may be substituted on a thickness-for-thickness basis. Because of their similar strength and stiffness properties and slightly higher density, use of these products in lieu of plywood will not compromise the STC or IIC ratings of the tested systems.

For additional information, see *APA Design/Construction Guide: Noise-Rated Systems*, Form W460.

FIGURE 38

PARTY WALL STC 50

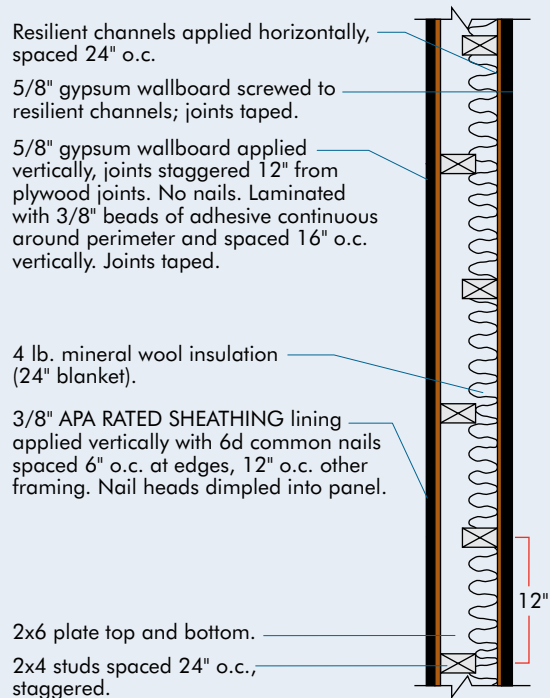
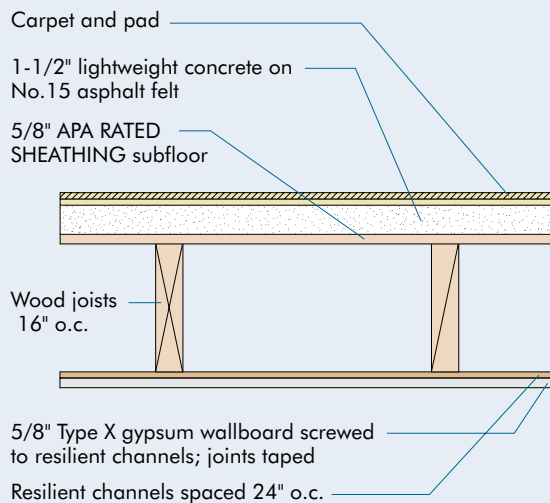

FIGURE 39

NOISE-RESISTANT FLOOR ASSEMBLY^a (Lightweight Concrete Over APA Panels) STC 58; IIC 73



a. Also meets minimum construction requirements for one-hour fire-rated floor-ceiling assembly per Underwriters Laboratory (U.L.) Design No. L514. Ref. Geiger and Hamme, Inc. tests CCA-10MT and CCA-11MT (1972).

Energy Conservation

Insulating Exterior Walls

With adoption of more stringent energy-efficiency regulations, it is increasingly important to build walls to meet new requirements as efficiently as possible. Continuous APA RATED SHEATHING can be used as part of the air barrier assembly on a building's exterior walls. Framed walls can be easily insulated to meet U-factor requirements found in energy standards. Figure 40 illustrates two construction options and their corresponding U-factors. One of the assemblies uses APA RATED SIDING (lap siding) over APA RATED SHEATHING and one shows siding panels applied over rigid foam insulation. The vapor retarder is installed on the inside of the wall framing for typical cold-climate construction. Check building code requirements for cold-climate type and location of the vapor retarder.

For additional information, see *IECC Compliance Options for Wood-Frame Wall Assemblies*, Form P320.

FIGURE 40

ENERGY-EFFICIENT WALL BRACING ASSEMBLIES

APA RATED LAP SIDING OVER WOOD STRUCTURAL PANEL SHEATHING AND ADVANCED FRAMING

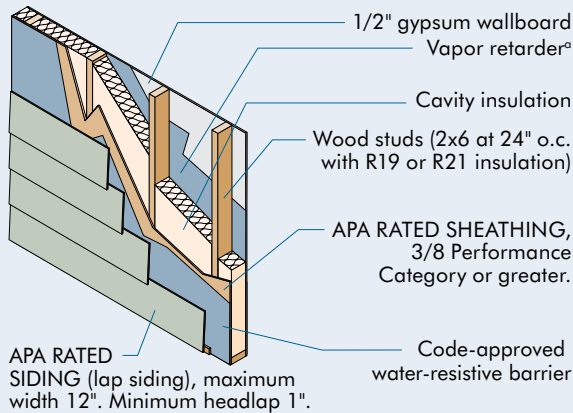

| Components | R-Values |
|--|----------|
| Outside Air Film (15 mph wind) | 0.17 |
| APA Rated Lap Siding | 0.59 |
| APA Rated Sheathing | 0.62 |
| Cavity Insulation (R21 fiberglass batts) | 21.00 |
| 2x6 Advanced Framing (20% framing factor) | 6.88 |
| 1/2" Gypsum Wallboard | 0.45 |
| Inside Air Film (still air) | 0.68 |
| Net Effective R-Value of Frame Wall Sections | 18.07 |
| Total Frame Wall U-Factor | 0.055 |

APA RATED SIDING OVER RIGID FOAM INSULATION SHEATHING AND CONVENTIONAL FRAMING

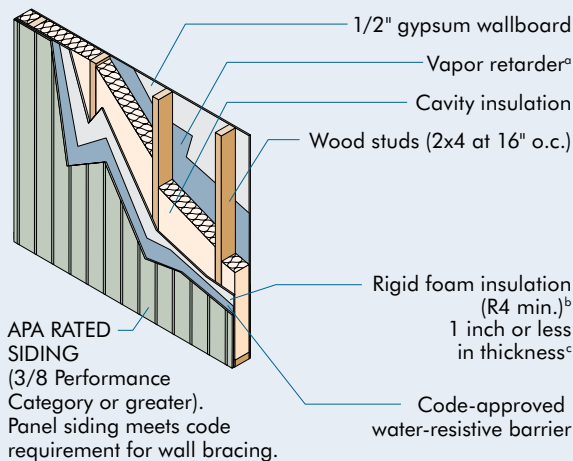

| Components | R-Values |
|---|-------------|
| Outside Air Film (15 mph wind) | 0.17 |
| APA Rated Siding (15/32) | 0.59 |
| Rigid Foam Insulation (1" thickness or less) | 4.00 (min.) |
| Cavity Insulation (R15 fiberglass batts) | 15.00 |
| 2x4 Conventional Framing (25% framing factor) | 4.38 |
| 1/2" Gypsum Wallboard | 0.45 |
| Inside Air Film (still air) | 0.68 |
| Net Effective R-Value of Frame Wall Sections | 17.72 |
| Total Frame Wall U-Factor | 0.056 |

- Refer to Section R702.7 in the IRC and Section 1405.3 in the IBC for climate-specific vapor retarder requirements.
- Consult rigid foam manufacturer for R-value and panel permeability values. (See *APA Technical Topics: Wood Moisture Content and the Importance of Drying in Wood Building Systems*, Form TT-111).
- See *APA Technical Note: APA Rated Siding Panels over Rigid Foam Insulation Sheathing*, Form C465.

Air Barrier Materials

According to the U.S. Department of Energy, air leakage can account for 30% or more of the heating and cooling costs in a typical home. Because of the significant negative impact of uncontrolled air infiltration, the International Energy Conservation Code (IECC) requires new residential construction:

- To have a continuous air barrier that meets the provisions of IECC Table R402.4.1.1, *Air Barrier and Insulation Installation*,
- To have air barrier components that are installed according to manufacturer’s instructions, or
- To be tested to verify that the air leakage rate does not exceed the maximum value specified for the climate zone.

For detailed requirements in local jurisdictions, check with the local building department.

OSB and plywood are excellent air barrier materials and are commonly used on walls as part of a building's air barrier assembly. When using either of these recognized air barrier materials, it is incumbent on the designer and builder to integrate them and the air barrier accessories (tapes, sealants, membranes, gaskets, etc.) with the many components of a building envelope (windows, doors, penetrations, building transitions, etc.) so that the air barrier assembly is continuous across the entire building envelope.

North American wood structural panels, 3/8 Performance Category or thicker, are recognized as air barrier materials by ASHRAE, the IRC, IECC and the National Building Code of Canada, as shown in Table 42.

While it is important to not confuse the air barrier and the vapor barrier in a wall assembly, it is also important to recognize the difference between the air barrier and the water-resistive barrier. When wood structural panels are used as a part of the wall air barrier assembly on an exterior wall, they still must be protected by a water-resistive barrier. The water-resistive barrier provides a secondary line of defense against the intrusion of water, such as wind-driven rain. The water-resistive barrier is a relatively inexpensive protection for structural components, reducing the risk of moisture accumulation and damage to wall components, such as wood wall sheathing and framing. While some materials qualify as both air barriers and water-resistive barriers, including wood structural panels manufactured with an approved water barrier, standard OSB and plywood wall sheathing always require use of a separate water-resistive barrier.

TABLE 42
AIR BARRIER MATERIALS^a

| Material | Thickness (minimum) |
|--|---------------------|
| Plywood | 3/8 in. |
| Oriented strand board | 3/8 in. |
| Extruded polystyrene insulation board | 1/2 in. |
| Foil-faced urethane insulation board | 1/2 in. |
| Exterior gypsum sheathing or interior gypsum board | 1/2 in. |
| Cement board | 1/2 in. |
| Built up roofing membrane | – |
| Modified bituminous roof membrane | – |
| Fully adhered single-ply roofmembrane | – |
| A Portland cement/sand parge, stucco, or gypsum plaster | 1/2 in. |
| Cast-in-place and precast concrete sealed with grout or paint | – |
| Sheet metal | – |
| Closed cell 2 lb/ft ³ nominal density spray polyurethane foam | 1 in. |

a. Section 5.4.3.1.3 of ANSI/ASHRAE/IES Standard 90.1-2016.

Thermal Resistance of Wood Structural Panels

For most wood structural panel applications, the most important thermal quality is resistance, or insulating effectiveness. While wood structural panels (plywood and OSB) can be made up of a number of different species, the thermal resistance property is relatively insensitive to such differences. For determining the overall coefficient of heat transmission (U), APA publications rely on the thermal resistance values for softwood published by the American Society of Heating, Refrigeration and Air Conditioning Engineers (ASHRAE). Use of this single value simplifies computations and produces only insignificant differences in resulting design heat losses. Table 43 shows thermal resistance, R, for several wood structural panel thicknesses.

TABLE 43

THERMAL RESISTANCE OF WOOD STRUCTURAL PANELS

| Panel Performance Category | Thermal Resistance, R ^{a,b} |
|----------------------------|--------------------------------------|
| 1/4 | 0.31 |
| 5/16 | 0.39 |
| 3/8 | 0.47 |
| 7/16 | 0.62 ^c |
| 15/32 | 0.65 ^d |
| 1/2 | 0.68 ^c |
| 19/32 | 0.74 |
| 5/8 | 0.78 |
| 23/32 | 0.90 |
| 3/4 | 0.94 |
| 7/8 | 1.09 |
| 1 | 1.25 |
| 1-1/8 | 1.41 |

a. Degree F-hr.-sq.ft./BTU

b. The tabulated thermal resistance (R) values are based on Douglas-fir-Larch plywood at 8% moisture content and 75°F except for those noted in Footnotes (c) and (d). For more information, refer to TenWolde, A, J.D. McNatt, and L. Krahn. 1988. *Thermal Properties of Wood and Wood Panel Products for Use in Building*. Report prepared for Oak Ridge National Laboratory. DOE/USDA-21697/1 and ORNL/Sub/87-21697/1. USDA Forest Products Laboratory. Madison, WI.

c. 2009 ASHRAE *Handbook of Fundamentals*, Chapter 26, Table 4.

d. Interpreted from note c.

RELATED PANEL SYSTEMS

The Permanent Wood Foundation

The Permanent Wood Foundation (PWF), also referred to as the All-Weather Wood Foundation (AWWF), is made up of pressure-preservative-treated below-grade stud walls built of lumber and APA trademarked plywood. The system is accepted for FHA mortgage insurance programs and accepted by model building codes and most state and local codes. And, whether full basement or crawl space, the PWF is adaptable to almost any site and light-frame building design.

For complete design and construction recommendations, contact the American Wood Council, 222 Catocin Circle SE, Suite 201, Leesburg, Virginia 20175 (www.awc.org) or the Southern Pine Council, 6660 Riverside Dr., Suite 212, Metairie, Louisiana 70003 (www.southernpine.com).

Plywood for Concrete Forming

Plywood is an ideal material for concrete forming. It produces smooth concrete surfaces and can be used repeatedly—some overlaid panels up to 200 times or more. The thinner panels can be bent easily for curved forms and liners. Plywood's excellent stiffness minimizes deflection during pouring. Its natural insulating qualities help provide more consistent curing conditions. The large panel size and light weight reduce form construction and stripping time. And various surface textures are available for imparting attractive and unusual concrete textures.

Although nearly any Exterior plywood can be used for concrete forming, a special panel called PLYFORM® is manufactured specifically for the purpose. PLYFORM also can be manufactured with a High Density Overlay (HDO) surface. HDO PLYFORM has an exceptionally hard surface for the smoothest possible concrete finishes and maximum number of pours. Structural I PLYFORM is stronger and stiffer than PLYFORM Class I, particularly in the cross-panel direction, and is sometimes used for high pressures where long dimension is parallel to supports. Additional plywood grades designed for concrete forming include special overlays and proprietary panels.

For complete design information, refer to *APA Design/Construction Guide: Concrete Forming*, Form V345.

Structural Insulated Panels

The structural insulated panel (SIP) offers the stiffness and load-handling capability of a stressed-skin panel plus light weight, high insulation values for relatively small thicknesses and fast panelized construction. Panels are prefabricated by sandwiching an insulating core material, such as polystyrene or polyurethane foam, between wood structural panel “skins.” A structural bond is formed between the core and the skins with structural adhesives or, in the case of some foam materials, by direct adhesion of foam to the skins.

With APA panel siding over the outside skin, structural insulated panels make attractive, energy-conserving walls on both residential and commercial buildings. A typical structural insulated wall panel will have Performance Category 7/16 wood structural panel skins on both faces. Check local building requirements relating to thermal barrier protection of plastic foam. For additional information, refer to *APA Product Guide: Structural Insulated Panels*, Form H650, or visit the Structural Insulated Panel Association (SIPA) at www.sips.org.

When used in wall applications, SIPs shall be manufactured in accordance with ANSI/APA PRS 610.1, *Standard for Performance Rated SIPs in Wall Applications*, as a requirement under Section R610 of the IRC.

APA Panels Over Metal Framing

Modern fastening methods permit the use of APA panels over metal framing. Self-drilling, self-tapping fasteners commonly are used to attach panels with a Performance Category up to 1-1/8 to steel flanges. Panels also can be fastened to lighter members, such as formed steel joists, with pneumatic or power tools and special hardened screw-shank nails or pins. Construction adhesives are recommended with hardened screw-shank nails. Consult metal-framing manufacturers for recommended adhesives. Since threads usually extend only part way up the shank of self-drilling, self-tapping screws and screw-shank nails, it is important to specify a length sufficient to engage the metal framing.

Typical panel-to-metal framing systems are illustrated in Figure 41.

Load-span recommendations are the same as for wood-frame systems. For more information, refer to *APA Design/Construction Guide: Wood Structural Panels Over Metal Framing*, Form T625.

APA Panel Systems Over Concrete Slabs

A system of APA panels over sleepers embedded in mastic has been successfully installed over concrete slabs. Tongue-and-groove panels eliminate the need for blocking between sleepers at panel edges and allow air circulation beneath the floor. A vapor barrier is essential directly above or below the slab. Preservative treatment of the sleepers is recommended when the slab is on or below grade, although panels normally will not require treatment.

Tongue-and-groove plywood can be installed over polystyrene or polyurethane foam. The foam, bonded to both the plywood and concrete slab with mastic, provides high insulating value and resistance to termites, rot and fungus. Exterior plywood with a Performance Category of 19/32 or greater is recommended. A vapor barrier, such as polyethylene, is required either directly above or below the concrete slab.

For additional information and applications see *APA Technical Topic TT-007, APA Wood Structural Panels Over Concrete Slabs*.

Special Floor Surfacing

Hardboard overlaid plywood (APA PLYRON®) is sometimes used as a finish floor, especially for industrial installation. Check your local dealer for availability. High Density Overlay (HDO) panels with a special heavy-duty screen-grid surface provide skid-resistant, long-wearing surfaces under foot traffic. And a number of liquid coatings—some suitable for balconies, porches, patio decks and other exterior applications—are also available.

FIGURE 41

TYPICAL PANEL-TO-METAL FRAMING SYSTEMS

Panels Nailed to Nailable Steel Joists

Hardened screw-shank nails required

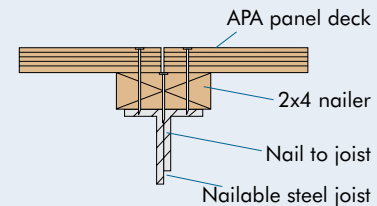
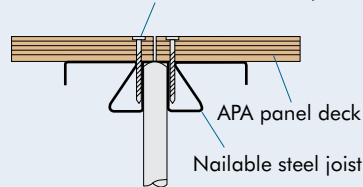

Nailer Anchored with Power Driven Fasteners

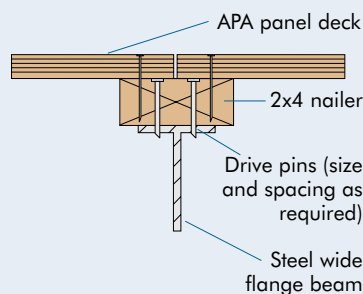

Panels Attached Directly to Formed Steel Joist

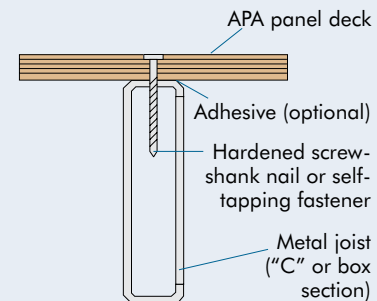

ABOUT APA

THE ENGINEERED WOOD ASSOCIATION

APA – The Engineered Wood Association is a nonprofit trade association of and for structural wood panel, glulam timber, wood I-joist, structural composite lumber, cross-laminated timber and other engineered wood product manufacturers. Based in Tacoma, Washington, APA represents approximately 175 mills throughout North America, ranging from small, independently owned and operated companies to large integrated corporations.

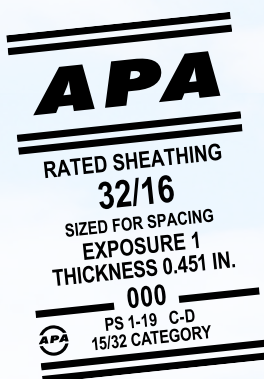
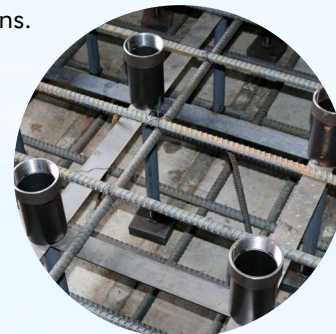

Always insist on engineered wood products bearing the **mark of quality**—the APA trademark. Your APA engineered wood purchase is not only your highest possible assurance of product quality, but an investment in the many trade services that APA provides on your behalf. The Association’s trademark appears only on products manufactured by member mills and is the manufacturer’s assurance that the product conforms to the standard shown on the trademark.

APA’s services go far beyond quality testing and inspection.

Research and promotion programs play important roles in developing and improving construction systems using wood structural panels, glulam, I-joists and structural composite lumber, and in helping users and specifiers to better understand and apply engineered wood products.

For the latest information in building strong, safe and durable structures, visit www.apawood.org.



APA offers a comprehensive set of services and tools for design and construction professionals specifying and using engineered wood products and building systems. If you're looking for detailed product information, training material or technical assistance, APA can help.

www.apawood.org

APA's website is your link to in-depth design and building support, including a library of more than 600 publications.

help@apawood.org

Email the APA Product Support Help Desk or call (253) 620-7400. Staffed by specialists who have the knowledge to address a diverse range of inquiries related to engineered wood, the Help Desk can answer your questions about specification and application of APA products.

www.apawood.org/field-services

Field representatives in many major U.S. cities and Canada can answer questions about APA trademarked products.

Engineered Wood Construction Guide

We have field representatives in many major U.S. cities and in Canada who can help answer questions involving APA trademarked products. For additional assistance in specifying engineered wood products, contact us:

APA HEADQUARTERS

7011 So. 19th St. ■ Tacoma, Washington 98466
(253) 565-6600 ■ Fax: (253) 565-7265

PRODUCT SUPPORT HELP DESK

(253) 620-7400 ■ help@apawood.org

DISCLAIMER

The information contained herein is based on APA – The Engineered Wood Association's continuing programs of laboratory testing, product research, and comprehensive field experience. Neither APA, nor its members make any warranty, expressed or implied, or assume any legal liability or responsibility for the use, application of, and/or reference to opinions, findings, conclusions, or recommendations included in this publication. Consult your local jurisdiction or design professional to assure compliance with code, construction, and performance requirements. Because APA has no control over quality of workmanship or the conditions under which engineered wood products are used, it cannot accept responsibility for product performance or designs as actually constructed.

Form No. E30X/Revised December 2019

© 2019 APA – The Engineered Wood Association



REPRESENTING THE ENGINEERED WOOD INDUSTRY